



Alessandro Marchiani

*La ditta A. Marchiani nasce a Firenze nel 1960  
producendo cornici  
grezze per quadri, mobili e affini. Già dai primi  
del 1920 il padre  
dell'attuale titolare, Alessandro  
Marchiani, lavorava e commercializ-  
zava legno nel cuore di Firenze restan-  
do per anni unico nel settore  
avendo una larga gamma di legnami pro-  
venienti da varie parti del mondo.*

*Dal 1985, con la prima fiera a Bologna, SACA EUROPE, la ditta espande le  
proprie conoscenze in mercati europei e mondiali,  
restando leader nel settore della produzione e della vendita di materiale grezzo.  
I legni utilizzati, sono generalmente: ramin, ayous, pino e abete giuntato.  
Su richiesta è possibile utilizzare anche altre essenze legnose.*

*Su richiesta, l'azienda esegue sagome su disegno del cliente:  
lisce, stampate a caldo o pastellate.*

*Possiamo consegnare gli articoli del nostro catalogo in piccole  
quantità che sono pronte in magazzino.*



Promuoviamo la  
Gestione Sostenibile  
delle Foreste

[www.pefc.it](http://www.pefc.it)

*The company A. Marchiani was founded In Florence in 1960  
as a manufacturer of grey-state frames and profiles  
and paintings, furniture and accessories.  
From the beginning of the 1920's, the father of  
Alessandro Marchiani, the present owner, worked and  
traded in wood in the heart of Florence, and for many years,  
A. Marchiani was the only company in its  
market sector with a large range of wood from  
various parts of the world. After the first edition  
of the trade fair , SACA EUROPE, in Bologna in 1985  
the company started*

*to grow on both the European and  
worldwide markets, remaining all the while lea-  
der in the production and sales of raw materials.*

*In general the woods used are: ramin, ayous,  
pine and laminated pine. Other essences may  
be used on request.*

*On request, the company also pro-  
duces models based on clients'*

*designs: flat, hot-printed or in  
pasta design. Small quantities of  
all catalogued articles are available  
ready from stock.*

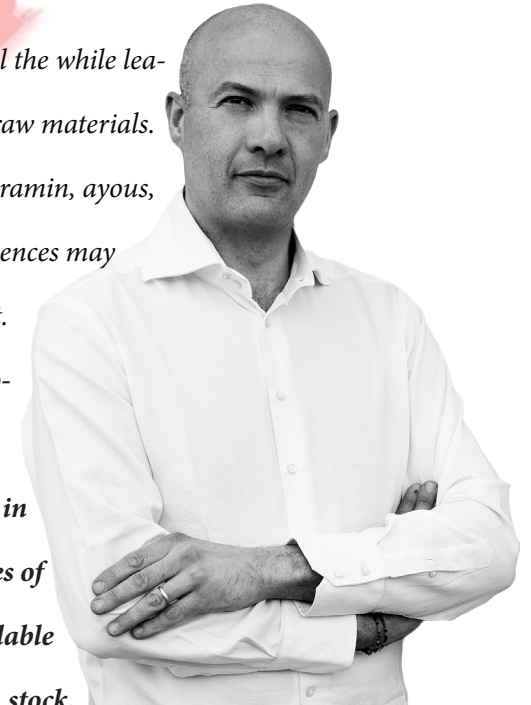

Matteo Marchiani

**a. marchiani**  
profili e cornici in legno

UFFICIO





**ASTE PASTELLATE**  
*Pasta design*

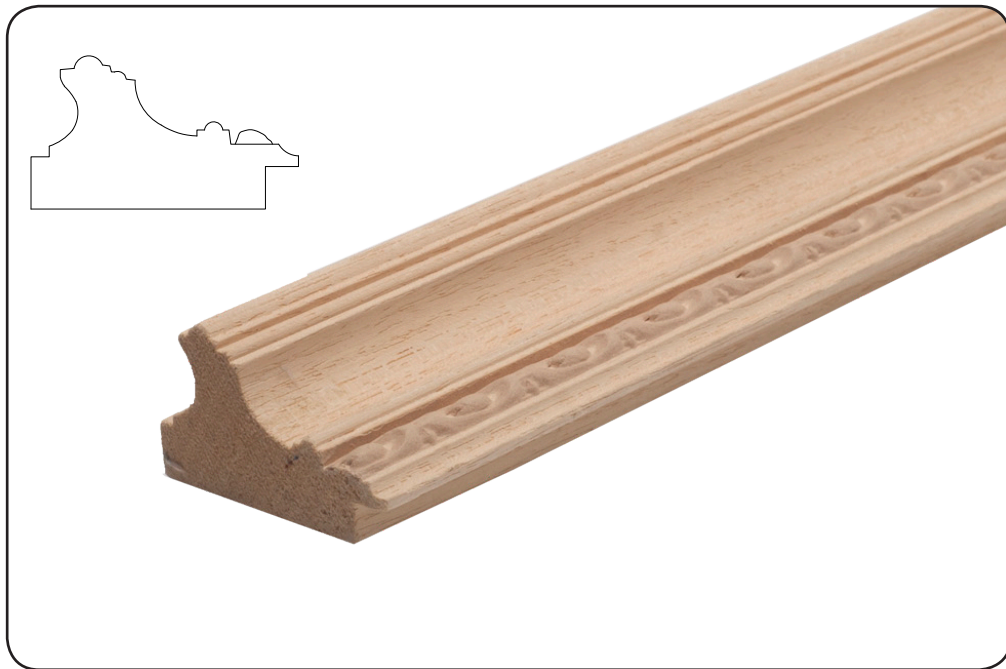

**4p**  
H 35 mm L 62 mm h Battente 10 mm

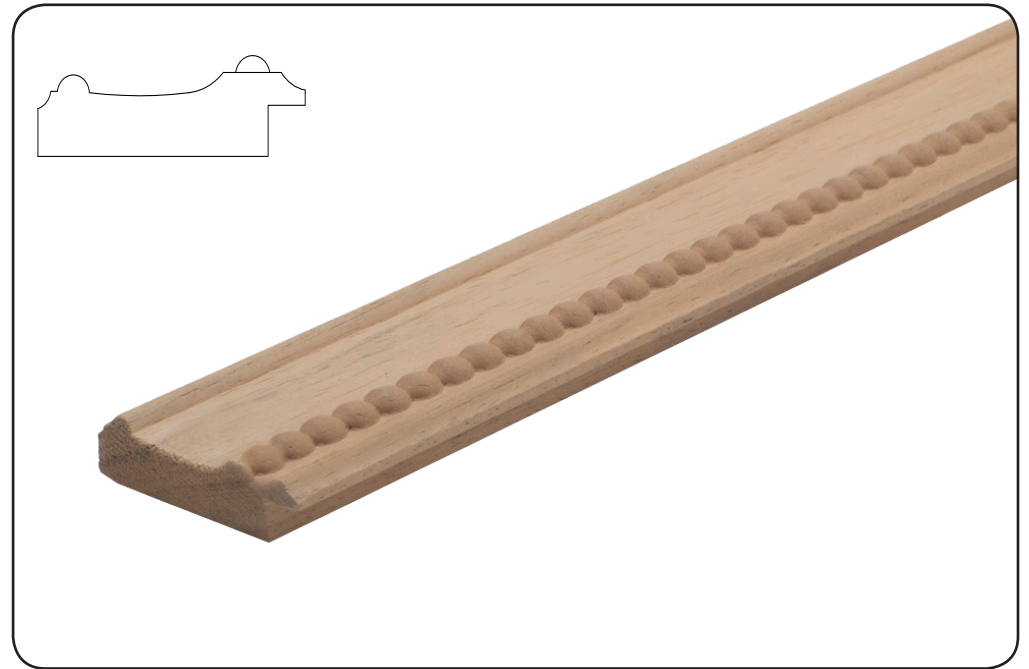

**5p**  
H 19 mm L 53 mm h Battente 10 mm

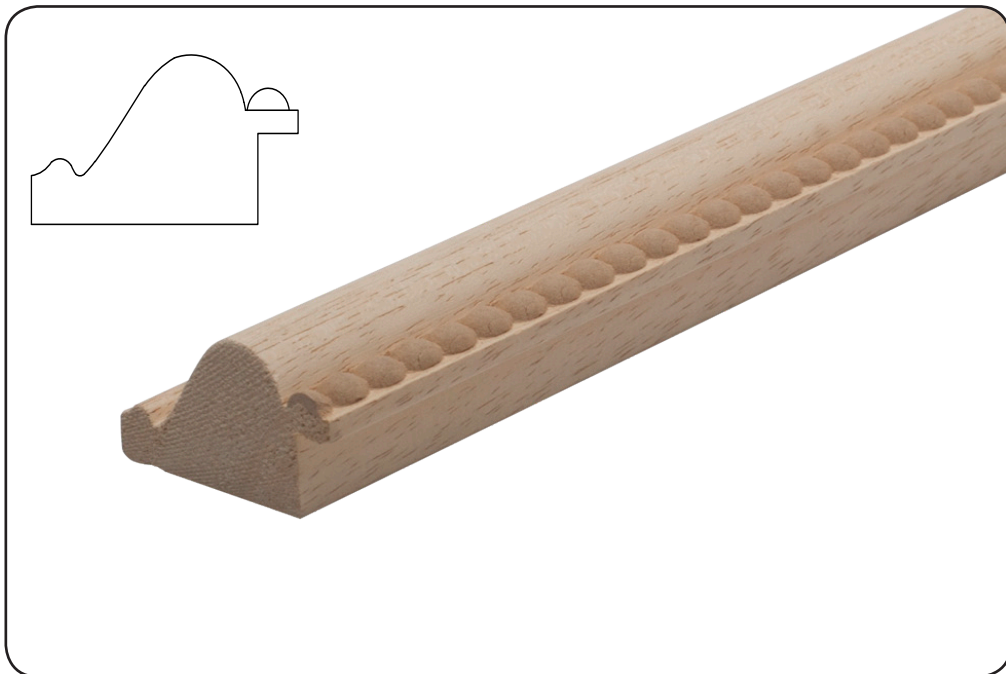

**6p**  
H 28 mm L 50 mm h Battente 15 mm



**8p**  
H 22 mm L 35 mm h Battente 11 mm



**10p**  
H 25 mm L 17 mm h Battente 14 mm

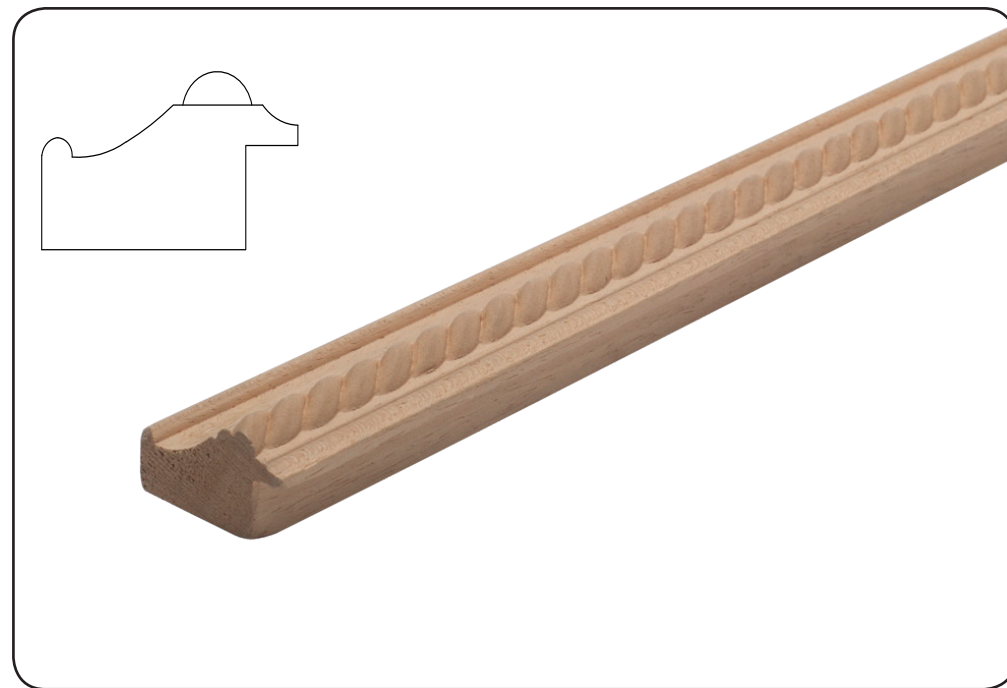

**11p**  
H 21 mm L 34 mm h Battente 12 mm



**12p**  
H 20 mm L 15 mm h Battente 11 mm



**17p**  
H 40 mm L 80 mm h Battente 27 mm



**18p**  
H 39 mm L 31 mm h Battente 23 mm



**20p**  
H 25 mm L 22 mm h Battente 17 mm

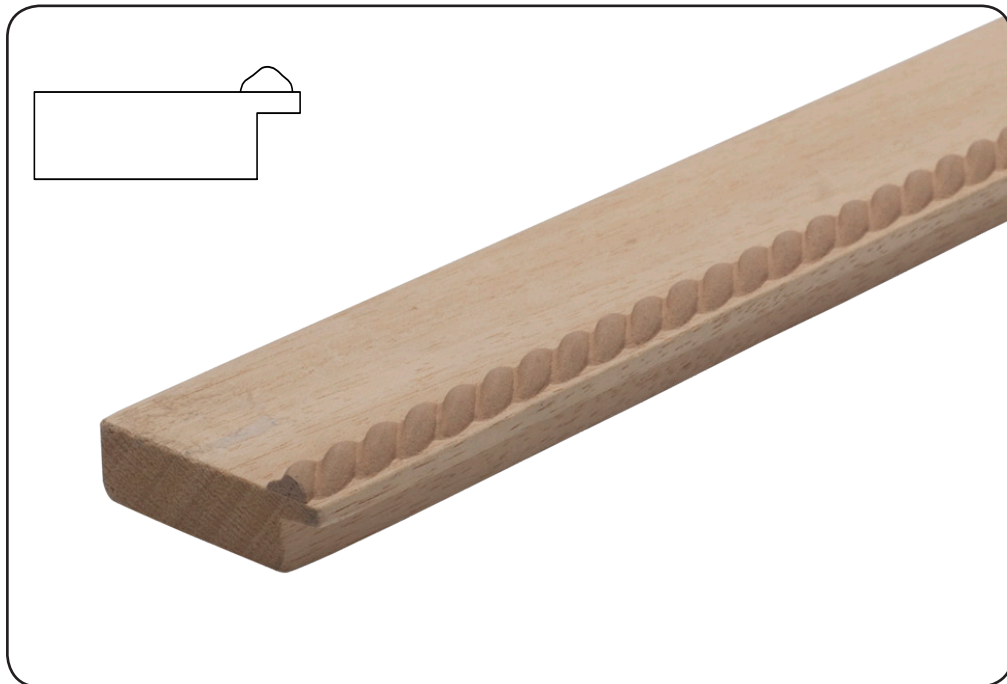

**22p**  
H 15 mm L 50 mm h Battente 10 mm

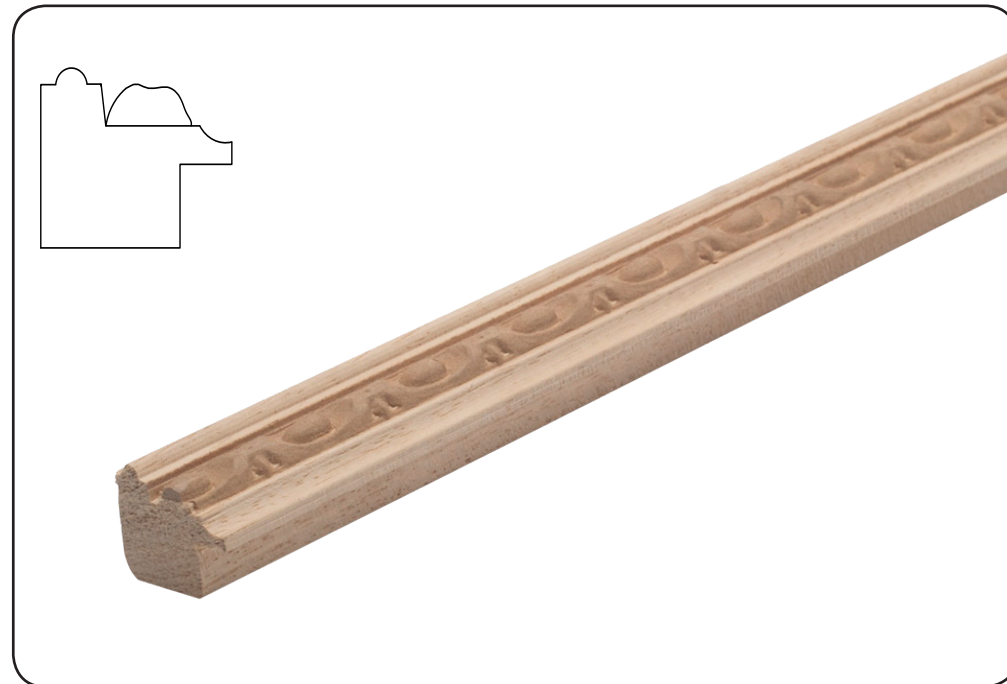

**23p**  
H 20 mm L 23 mm h Battente 9 mm



**26p**  
H 35 mm L 83 mm h Battente 23 mm

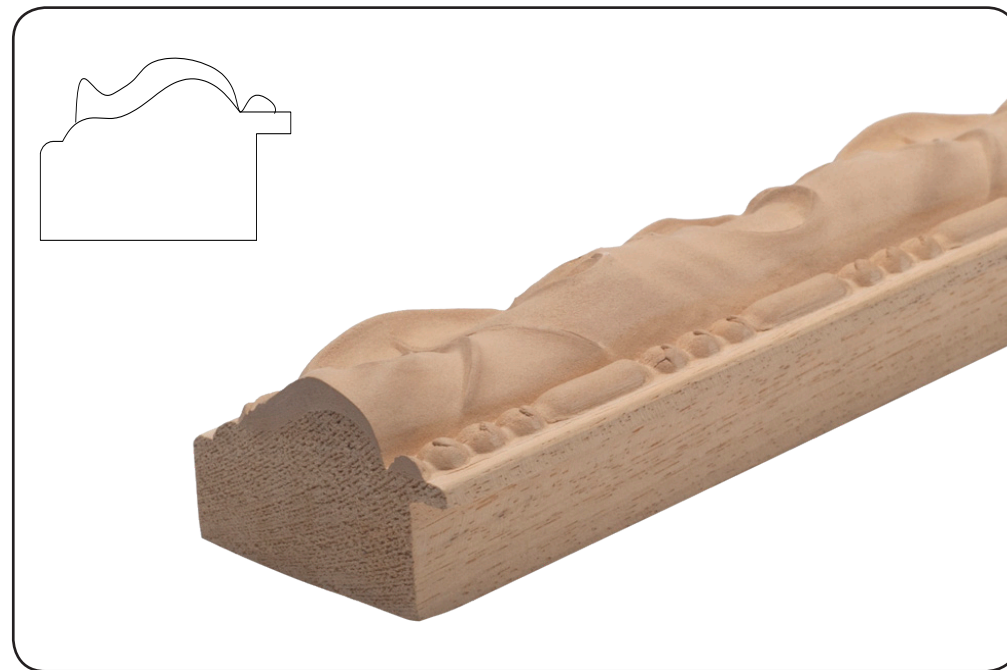

**34p**  
H 49 mm L 75 mm h Battente 27 mm



**35p**  
H 45 mm L 78 mm h Battente 27 mm

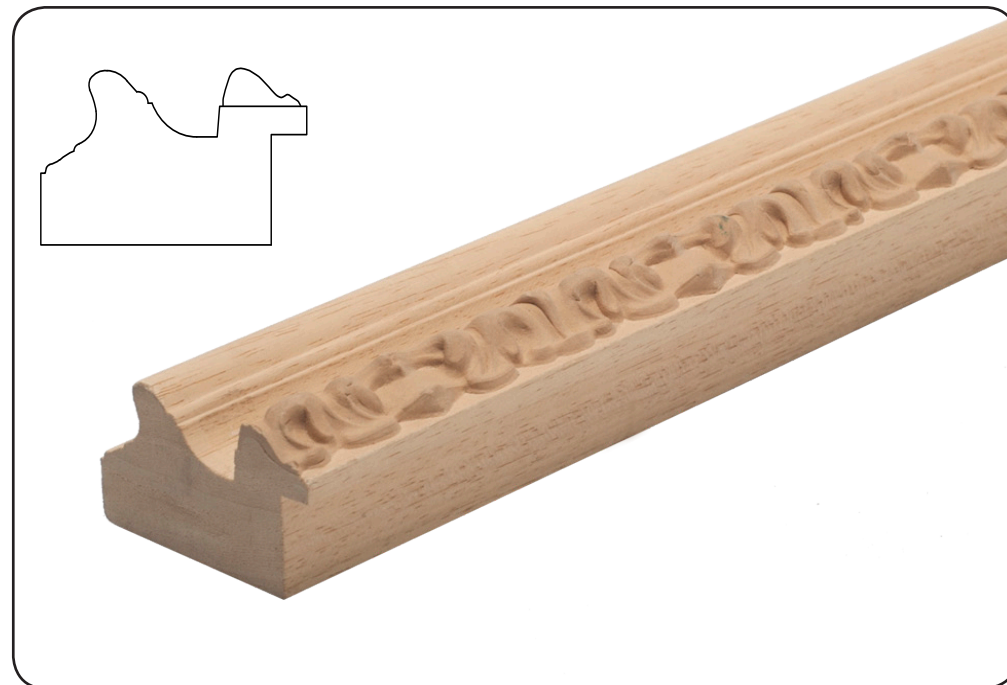

**36p**  
H 30 mm L 53 mm h Battente 20 mm

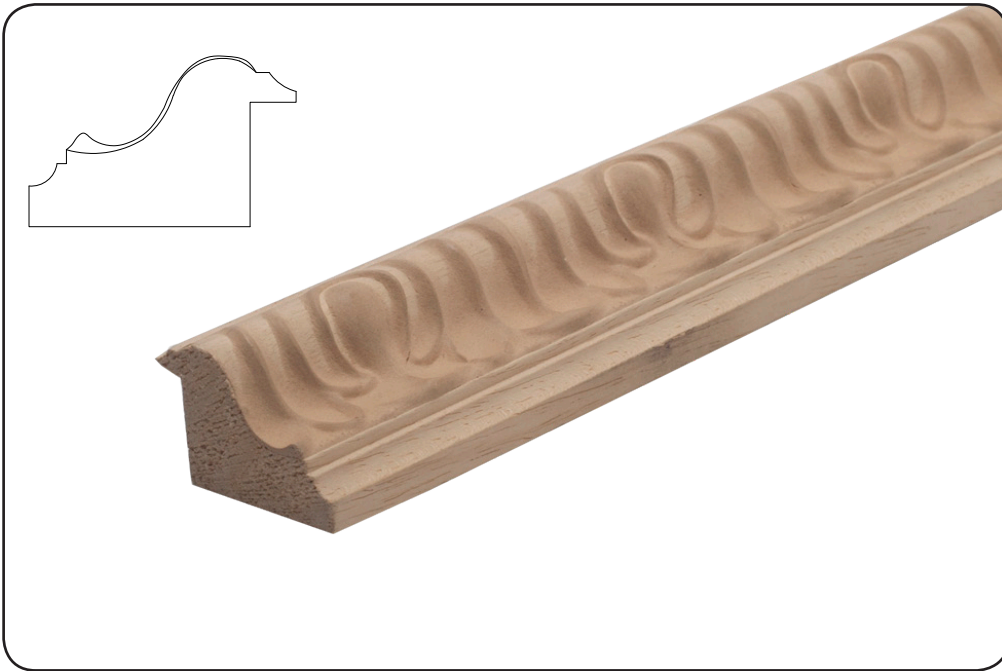

**40p**  
H 31 mm L 48 mm h Battente 23 mm

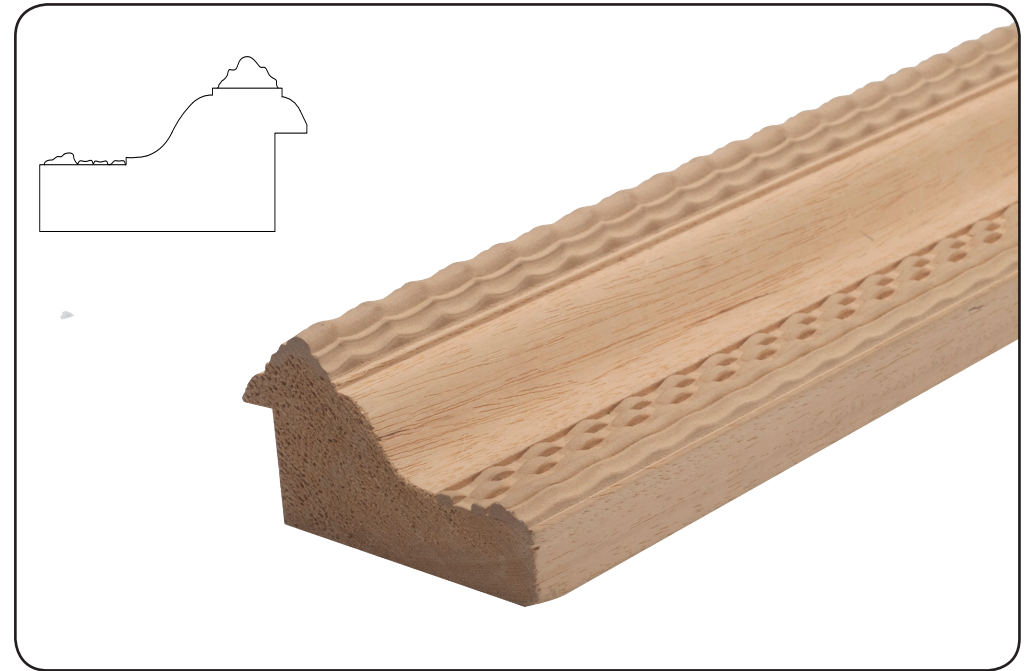

**44p**  
H 49 mm L 86 mm h Battente 27 mm



**50p**  
H 51 mm L 105 mm h Battente 27,5 mm



**51p**  
H 51 mm L 105 mm Battente 17 mm



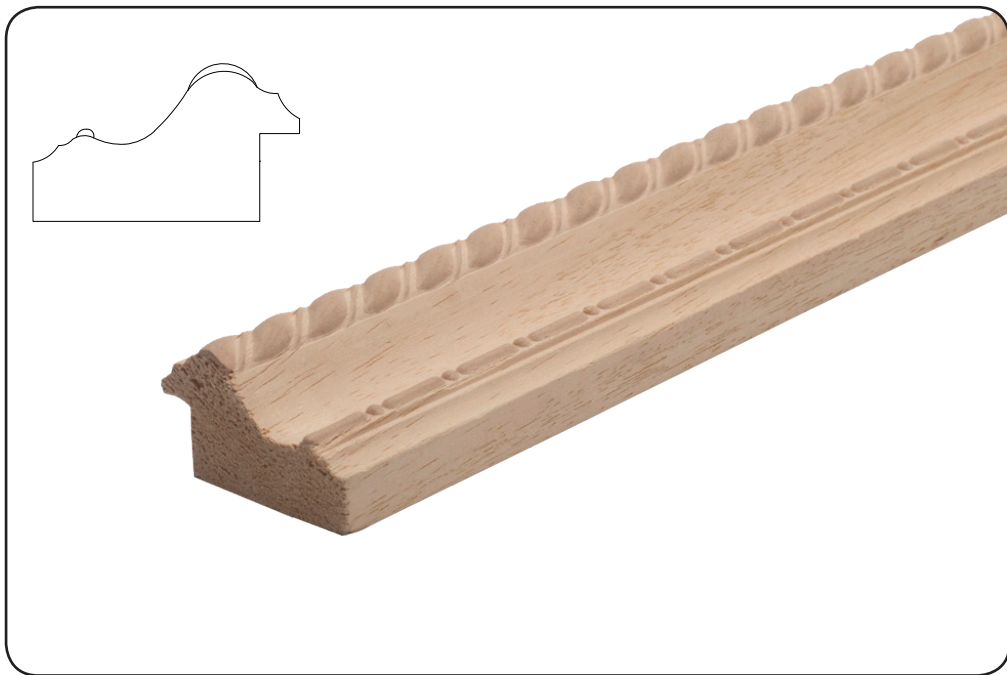

**53p**  
H 30 mm L 50 mm h Battente 16 mm

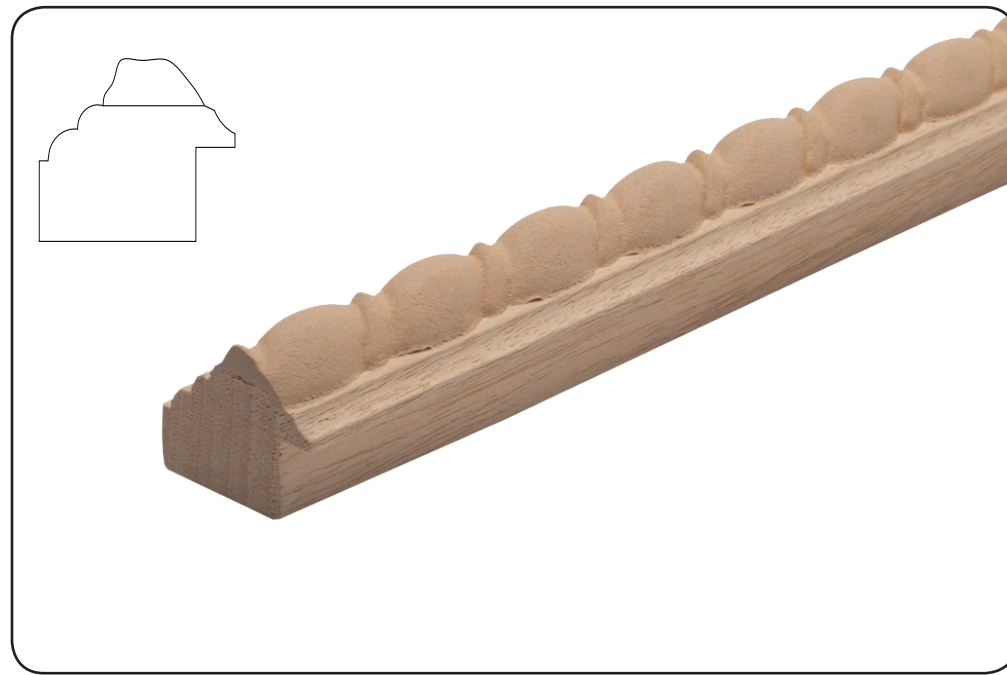

**56p**  
H 34 mm L 40 mm h Battente 17 mm

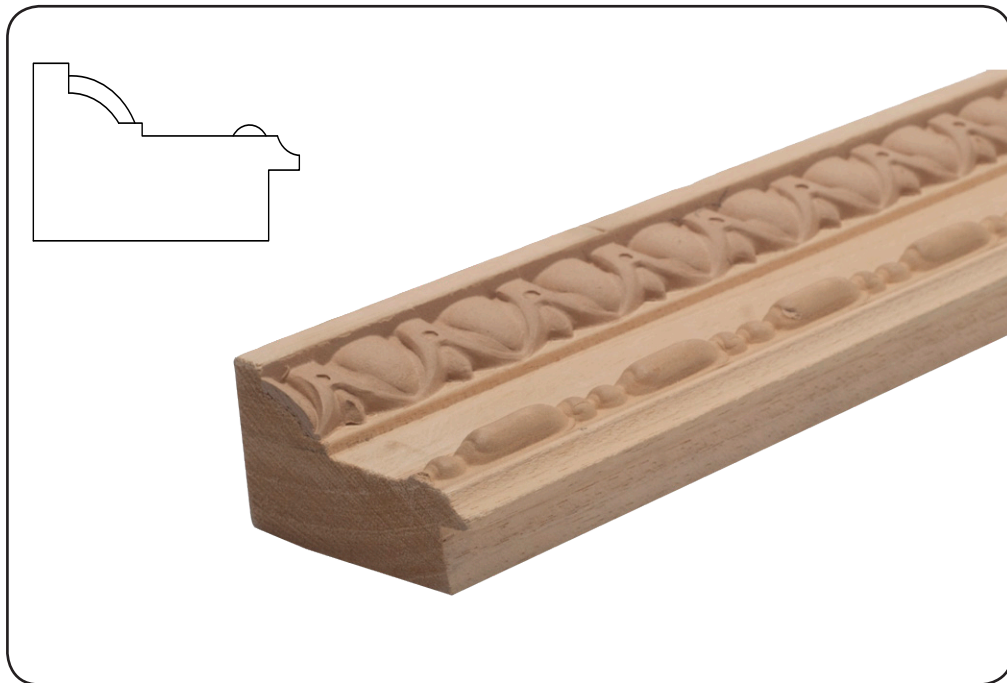

**59p**  
H 41 mm L 71 mm h Battente 17 mm



**63p**  
H 70 mm L 89 mm h Battente 20 mm



**65p**  
H 29 mm L 50 mm Battente 12 mm



**69p**  
H 40 mm L 64 mm Battente 26 mm



**70p**  
H 49 mm L 89 mm h Battente 17 mm



**72p**  
H 51 mm L 88 mm h Battente 21 mm



**73p**  
H 31 mm L 49 mm h Battente 11 mm



**75p**  
H 34 mm L 55 mm h Battente 15 mm



**76p**  
H 44 mm L 60 mm h Battente 28 mm



**78p**  
H 50 mm L 88 mm h Battente 27 mm



**84p forato**  
H 44 mm L 92 mm h Battente 25 mm



**84p**  
H 44 mm L 92 mm h Battente 25 mm

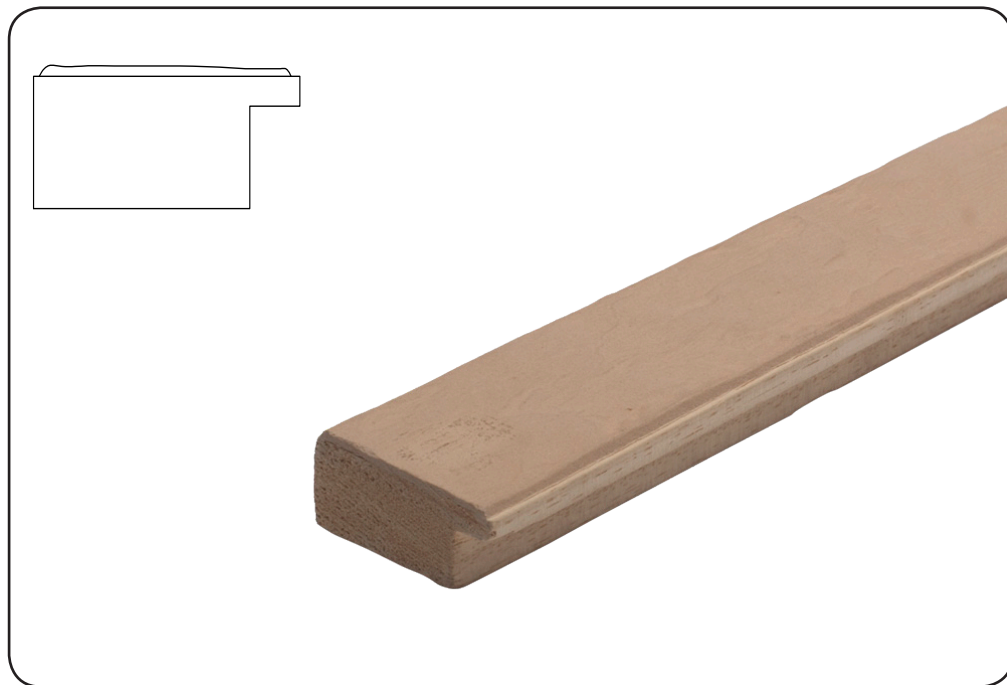

**86p**  
H 20 mm L 42 mm h Battente 13 mm

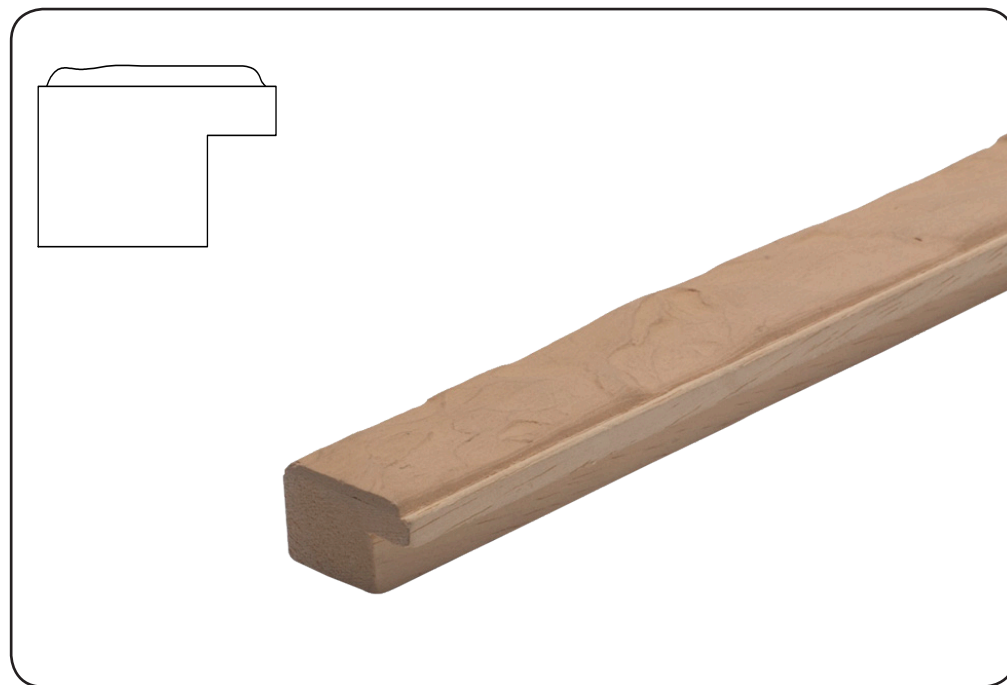

**87p**  
H 19 mm L 27 mm h Battente 10 mm



**100p**  
H 51 mm L 60 mm h Battente 15 mm

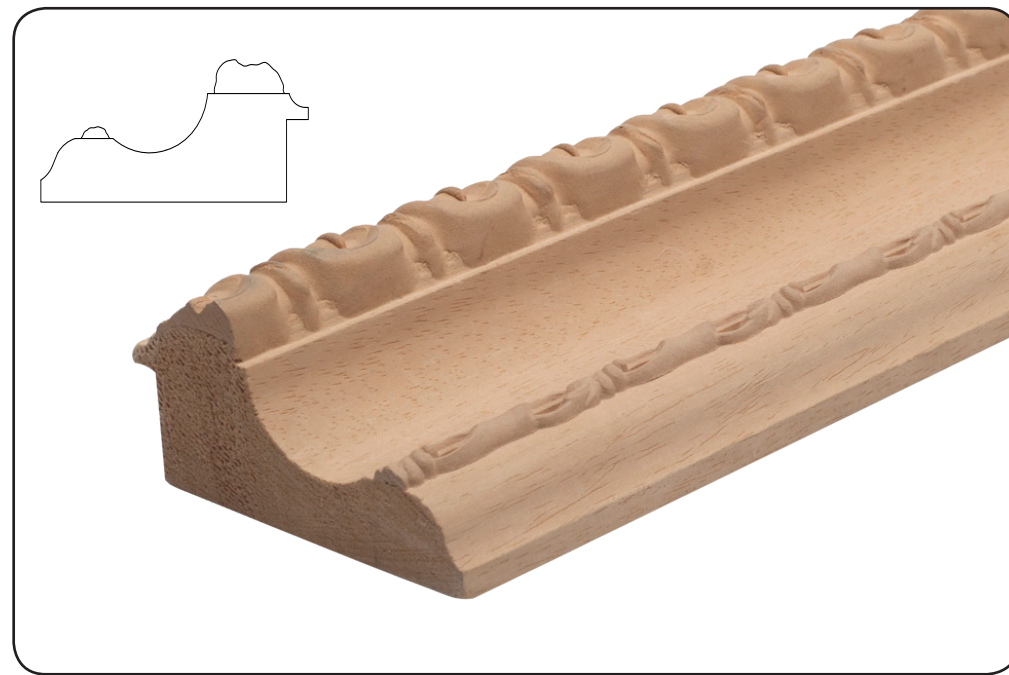

**123p**  
H 48 mm L 99 mm h Battente 27 mm

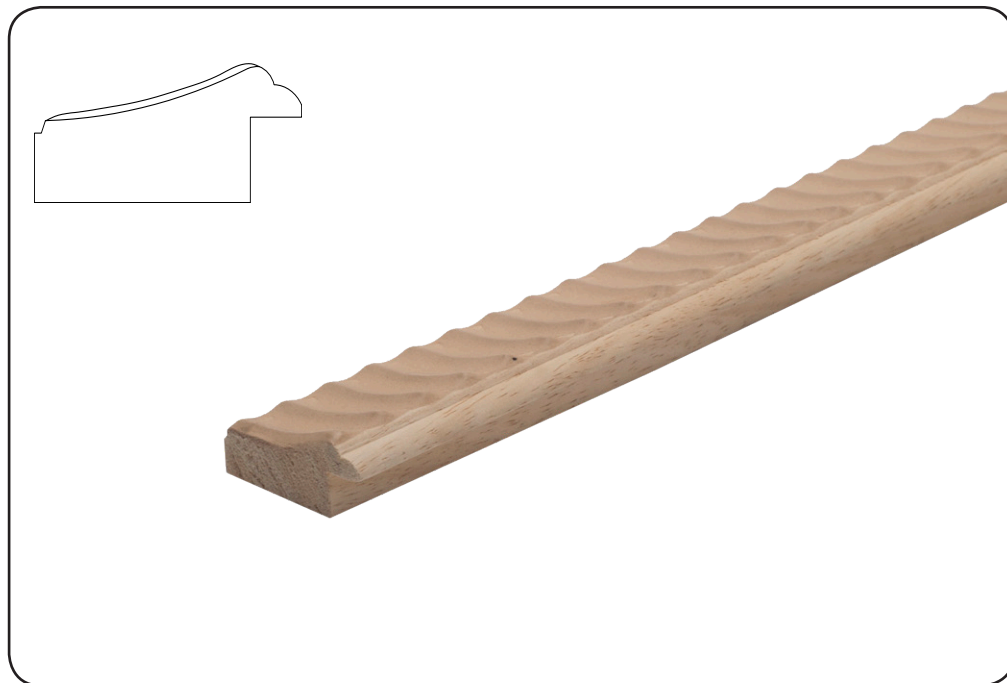

**125p**  
H 20 mm L 40 mm h Battente 11 mm



**126p**  
H 73 mm L 96 mm h Battente 27 mm

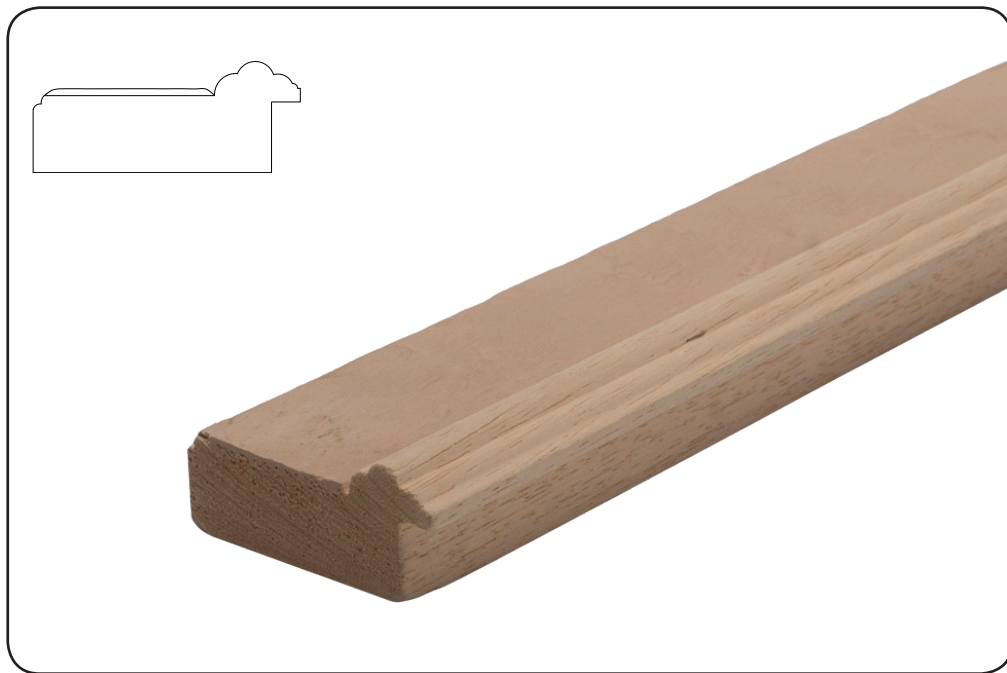

**128p**  
H 28 mm L 63 mm h Battente 18 mm

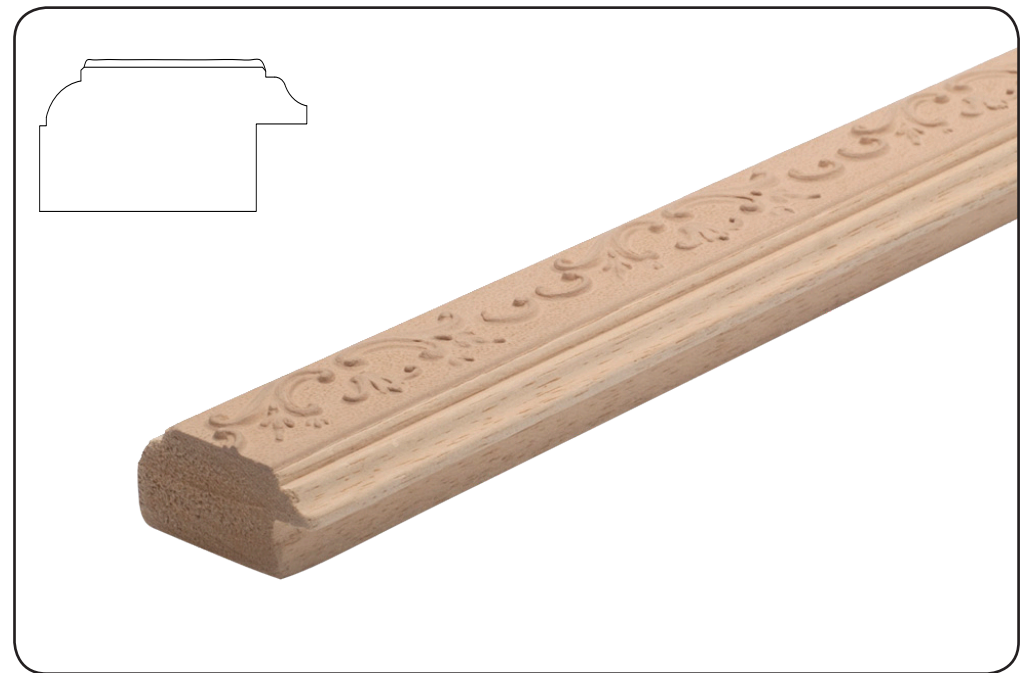

**134p**  
H 22 mm L 45 mm h Battente 11 mm



**135p**  
H 40 mm L 25 mm h Battente 23 mm



**137p**  
H 17 mm L 12 mm Battente 9 mm

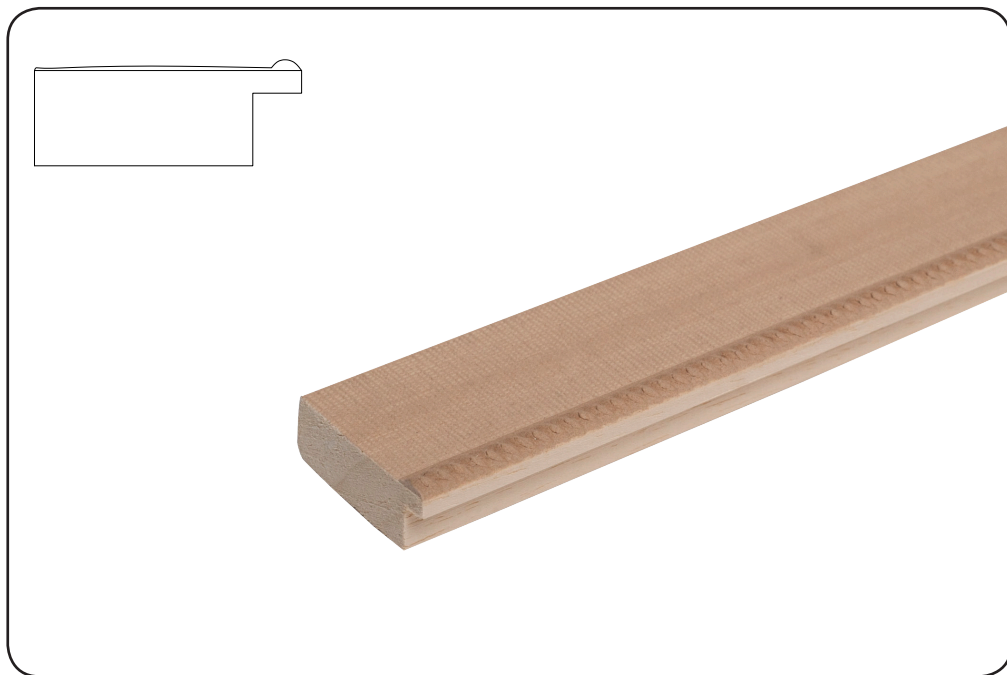

**138p**  
H 17 mm L 45 mm h Battente 10 mm



**140p**  
H 35 mm L 50 mm h Battente 20 mm



**141p**  
H 46 mm L 61 mm h Battente 22 mm



**142p**  
H 31 mm L 32 mm h Battente 14 mm

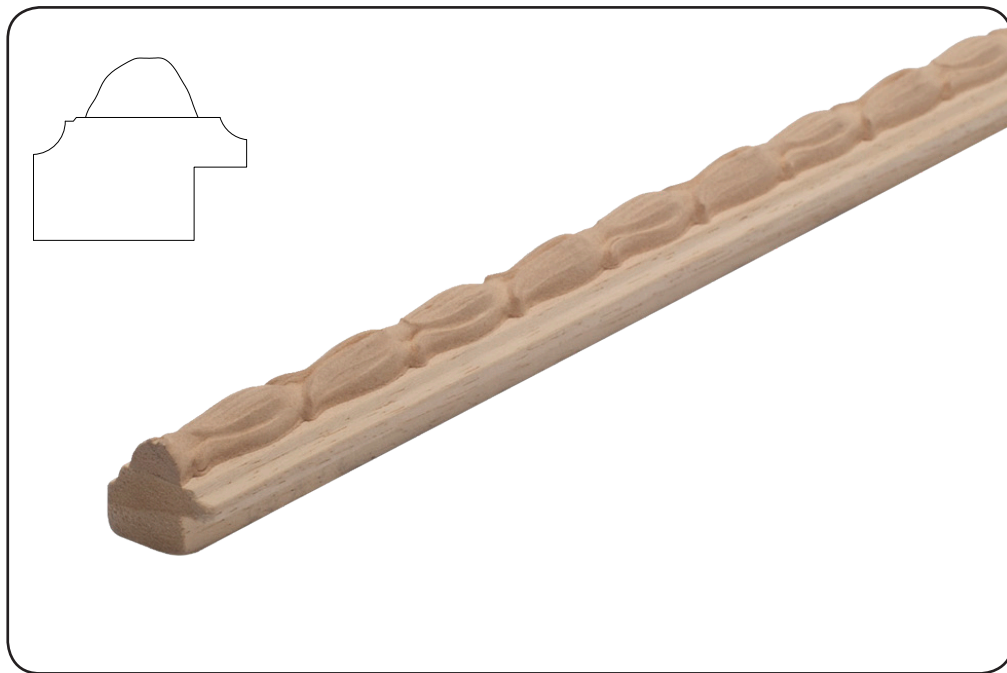

**145p**  
H 21 mm L 24 mm h Battente 9 mm



**146p**  
H 25 mm L 85 mm h Battente 17 mm

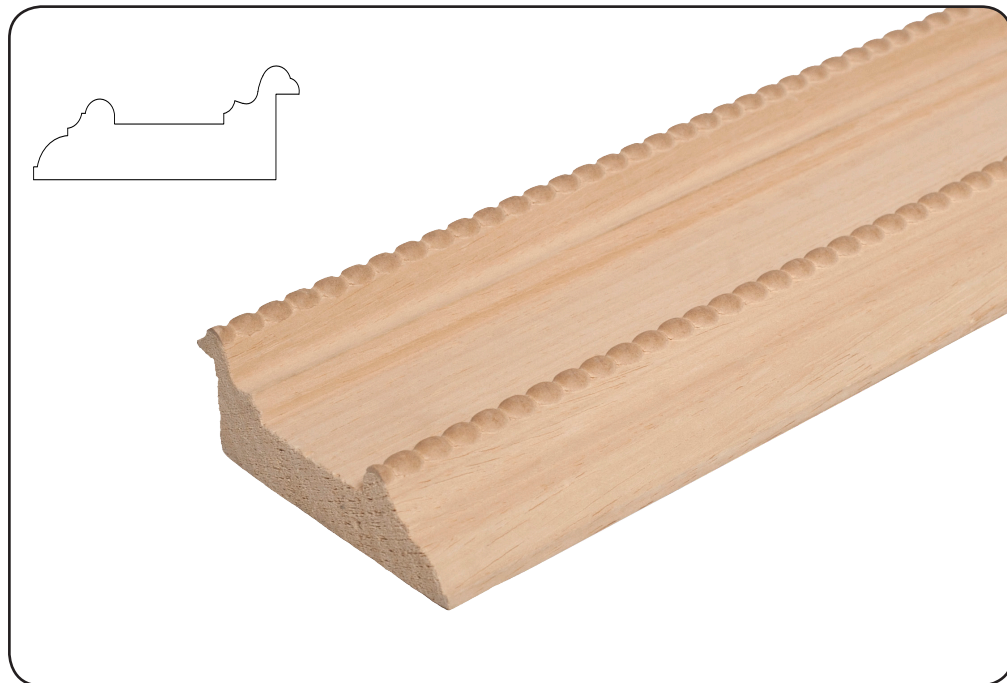

**149p**  
H 35 mm L 95 mm h Battente 27 mm



**157p**  
H 50 mm L 70 mm h Battente 27 mm





**158p**  
H 40 mm L 30 mm h Battente 27 mm

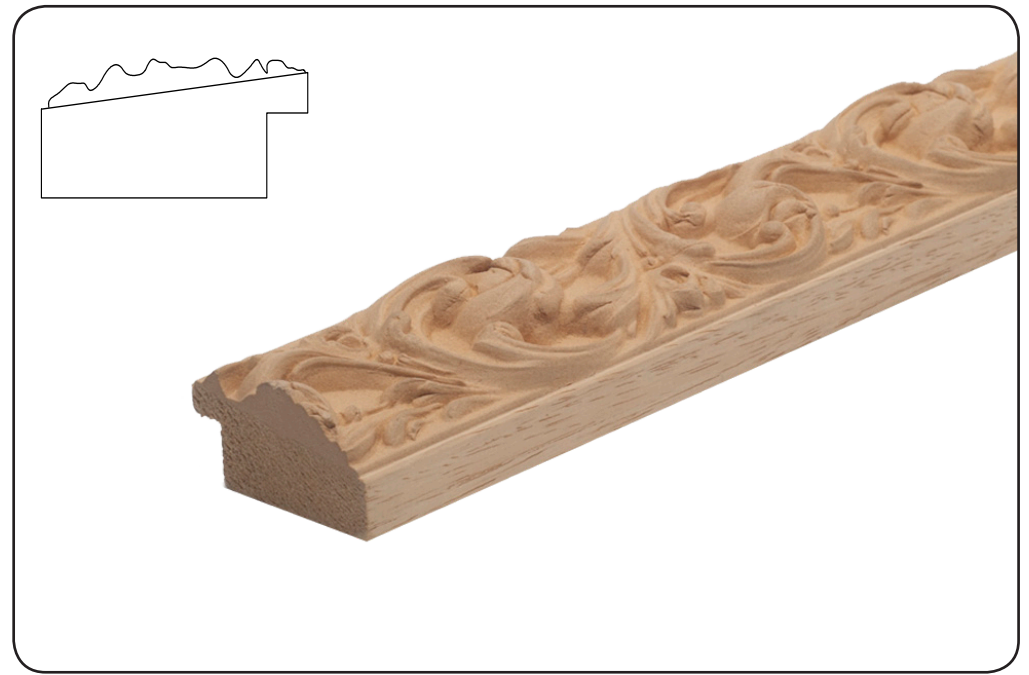

**160p**  
H 27 mm L 49 mm h Battente 14 mm

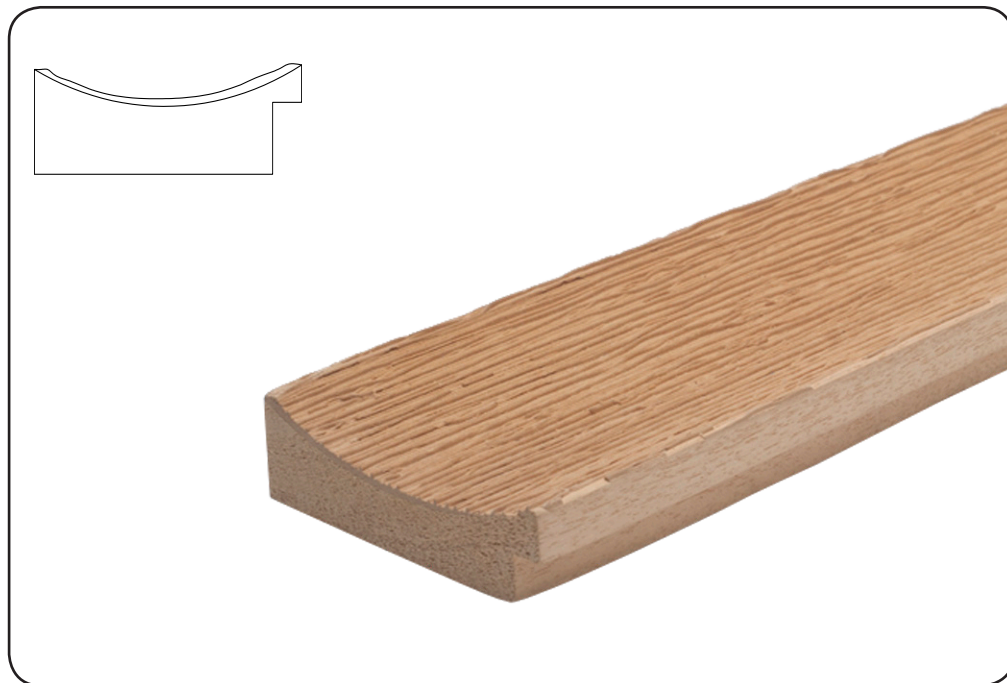

**162p**  
H 28 mm L 90 mm h Battente 13 mm



**164p**  
H 26 mm L 27 mm h Battente 12 mm

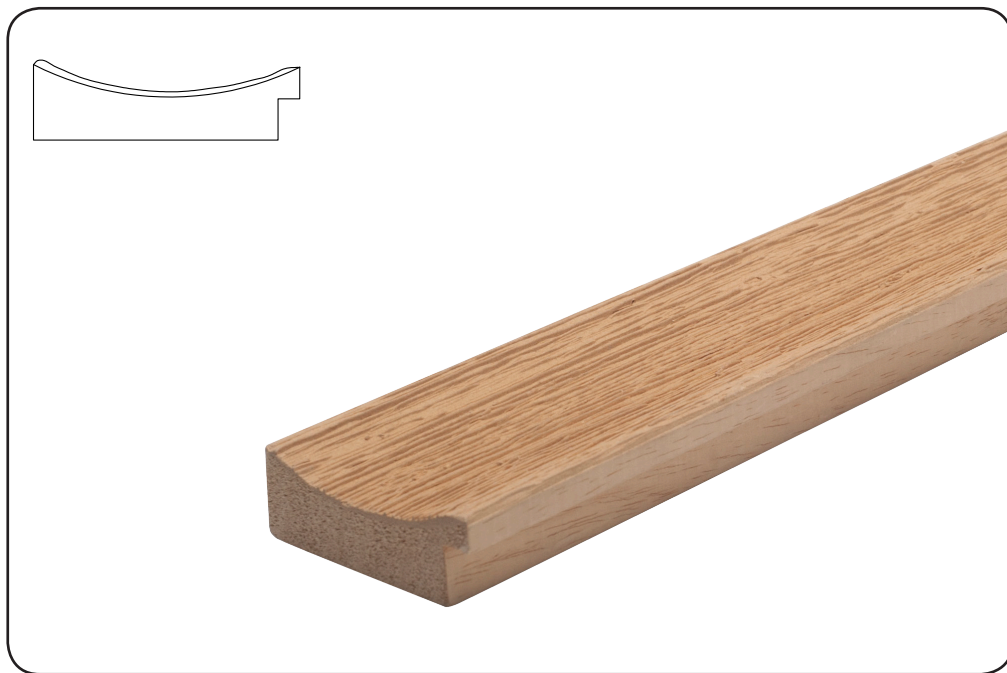

**166p**  
H 24 mm L 68 mm h Battente 15 mm

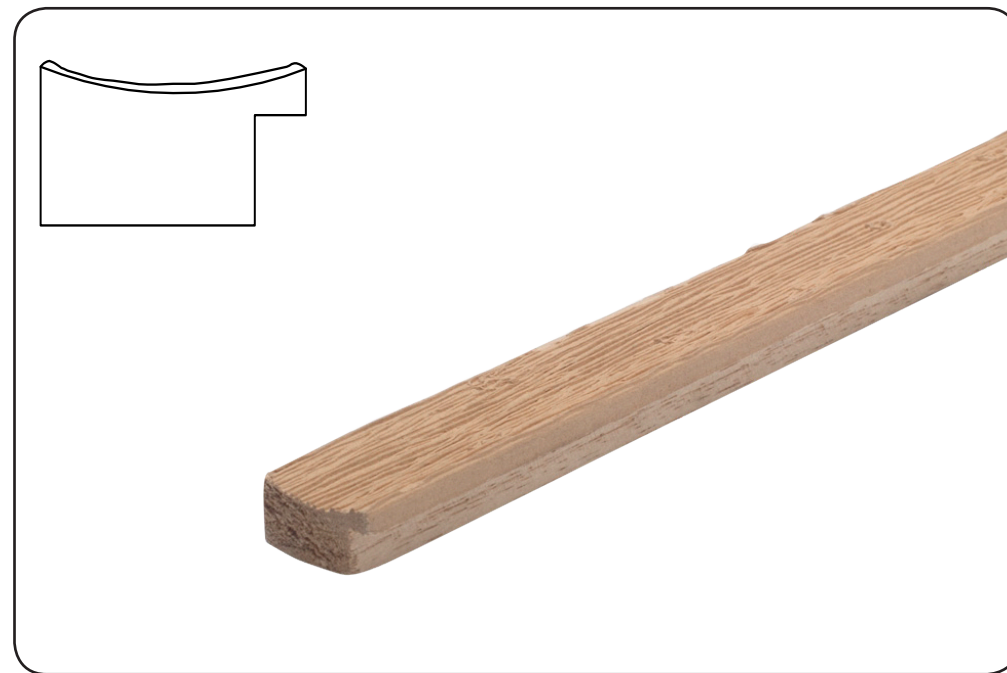

**170p**  
H 15 mm L 28 mm h Battente 10 mm



**171p**  
H 30 mm L 98 mm h Battente 20 mm

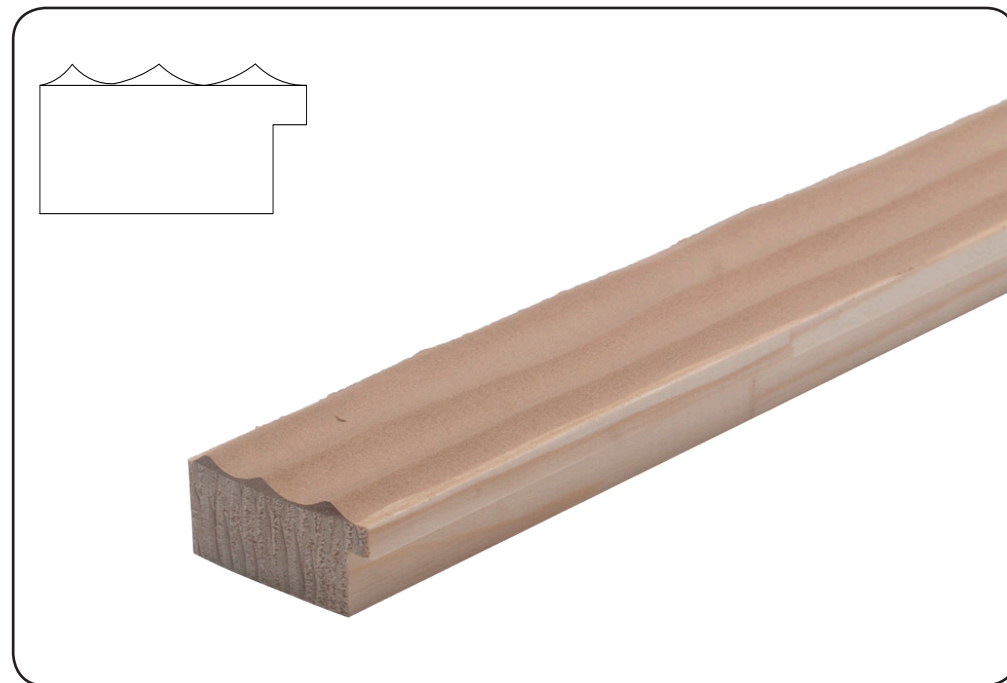

**172p**  
H 22 mm L 49 mm h Battente 14 mm

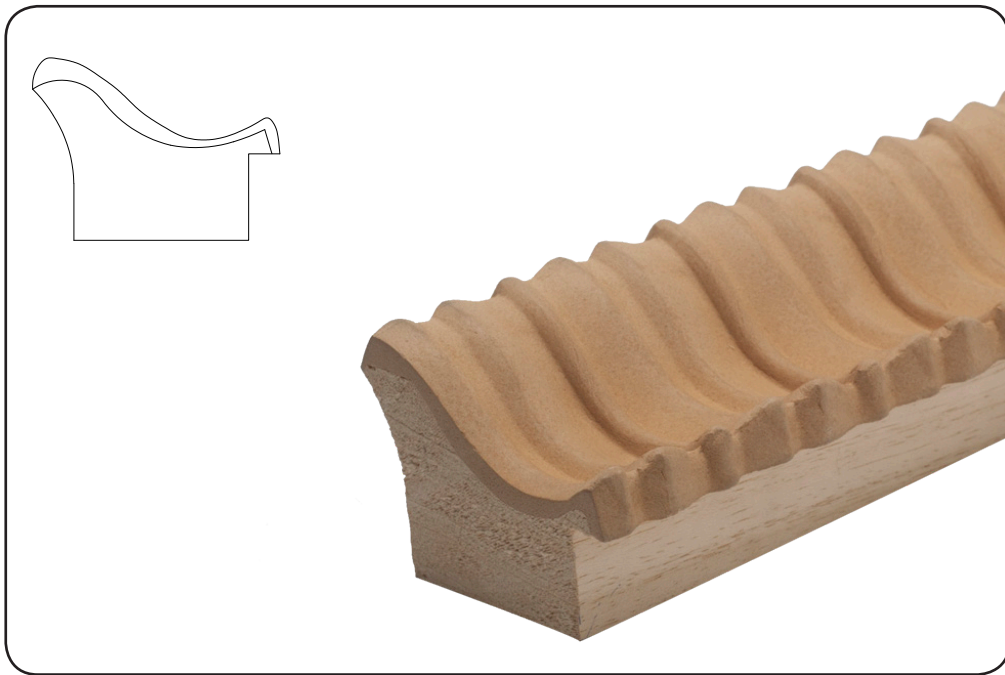

**174p**  
H 58 mm L 78 mm h Battente 28 mm

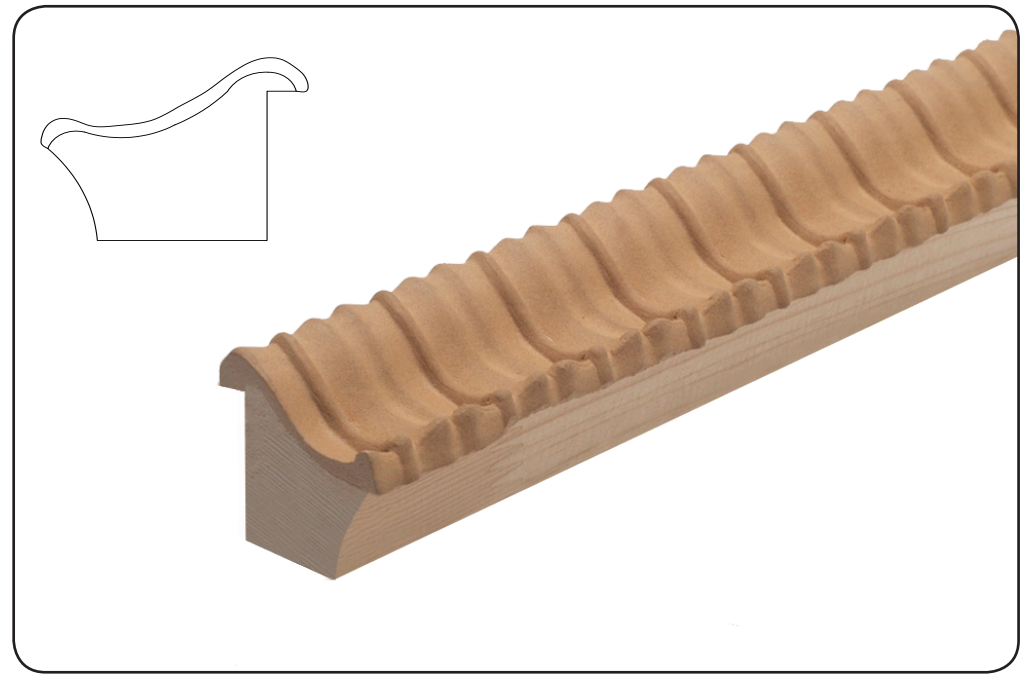

**175p**  
H 40 mm L 44 mm h Battente 32 mm

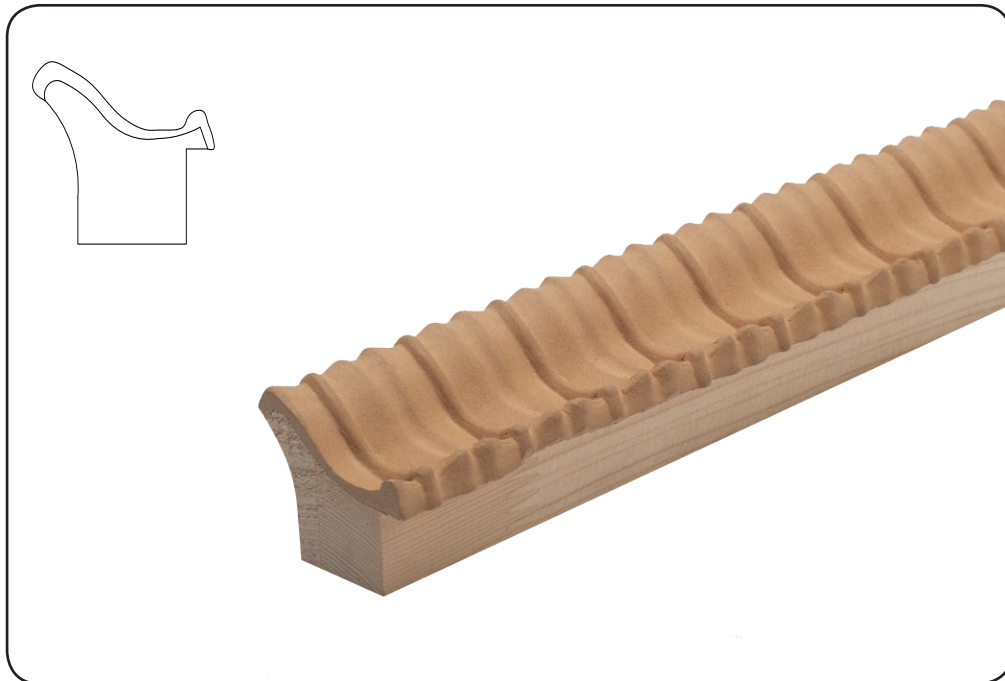

**176p**  
H 40 mm L 44 mm h Battente 21 mm

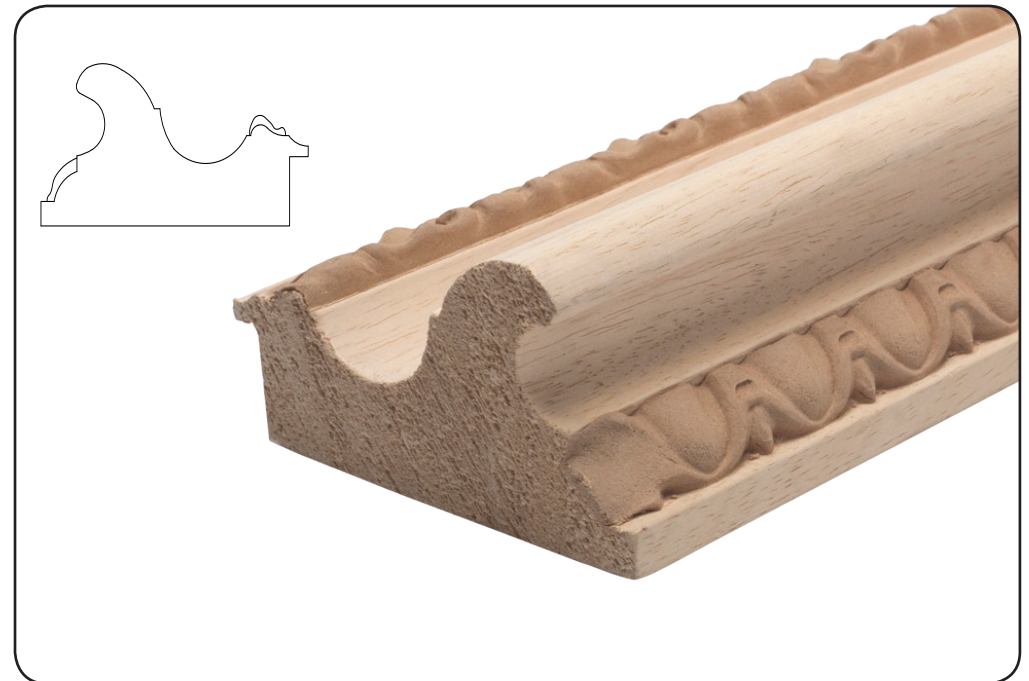

**177p**  
H 62 mm L 118 mm h Battente 27 mm



**179p**  
H 23 mm L 29 mm h Battente 14 mm



**185p**  
H 37 mm L 86 mm h Battente 20 mm

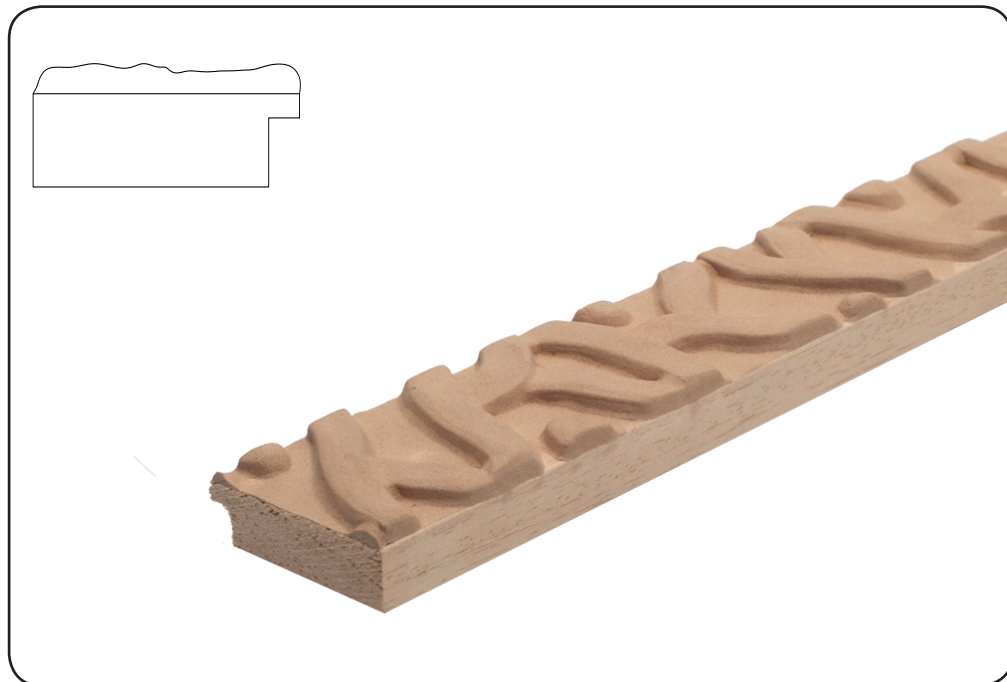

**187p**  
H 19 mm L 47 mm h Battente 10 mm



**188p**  
H 36 mm L 62 mm h Battente 20 mm



**189p**  
H 25 mm L 44 mm h Battente 10 mm

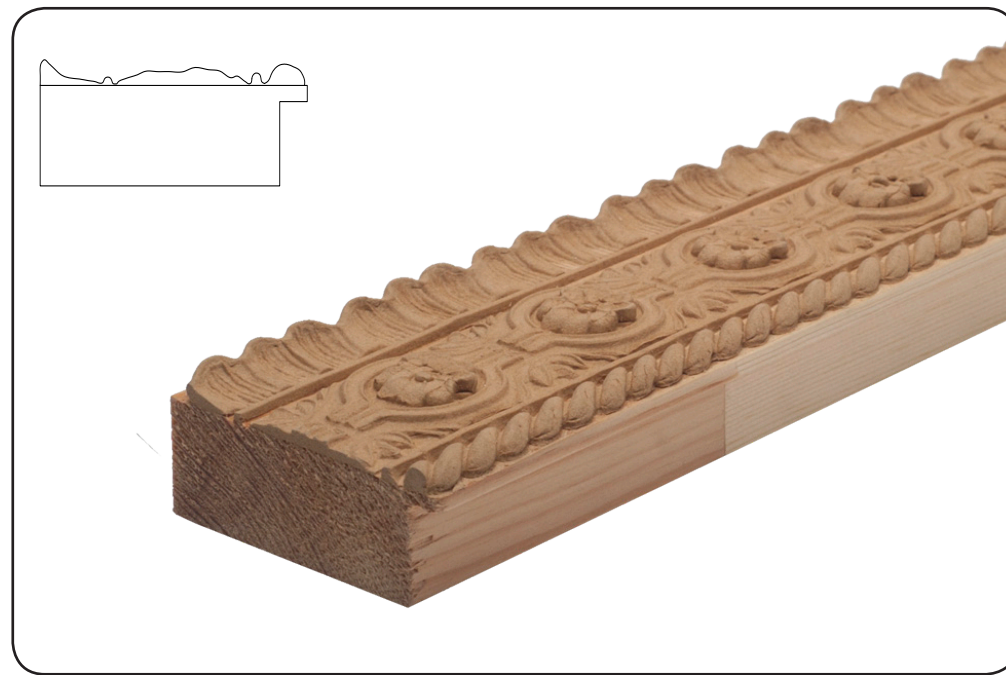

**190p**  
H 28 mm L 69 mm h Battente 19 mm

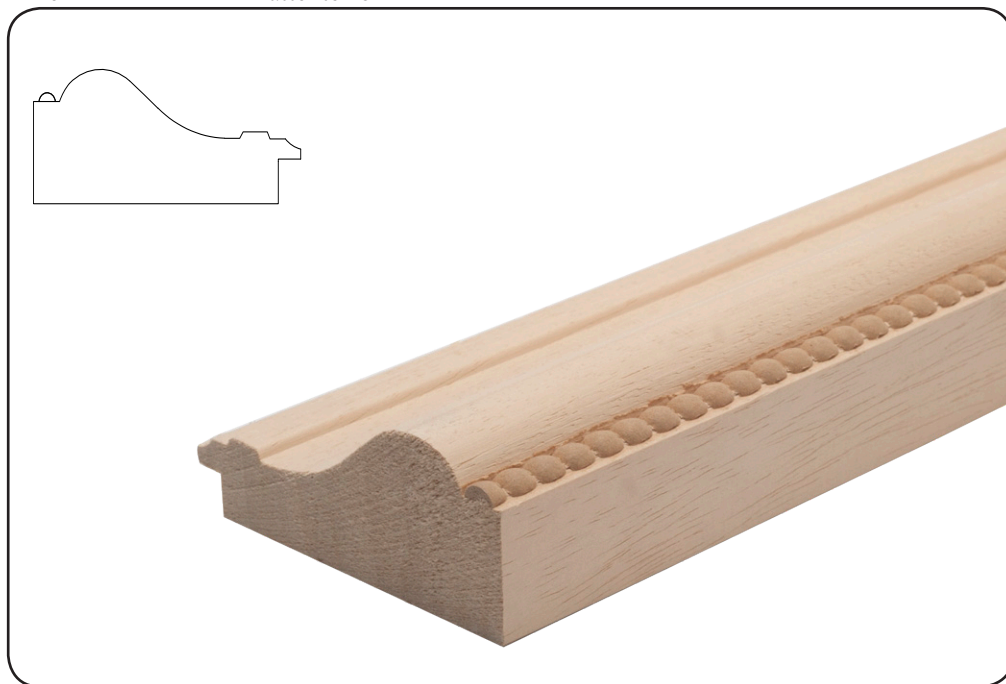

**216p**  
H 40 mm L 94 mm h Battente 13 mm

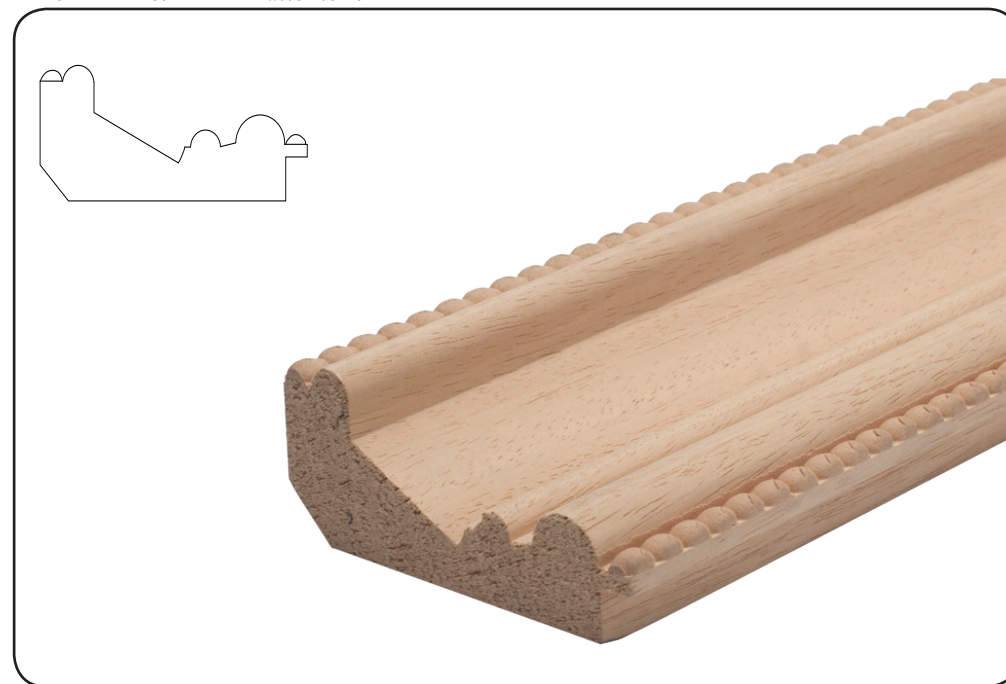

**295p**  
H 41 mm L 95 mm h Battente 12 mm

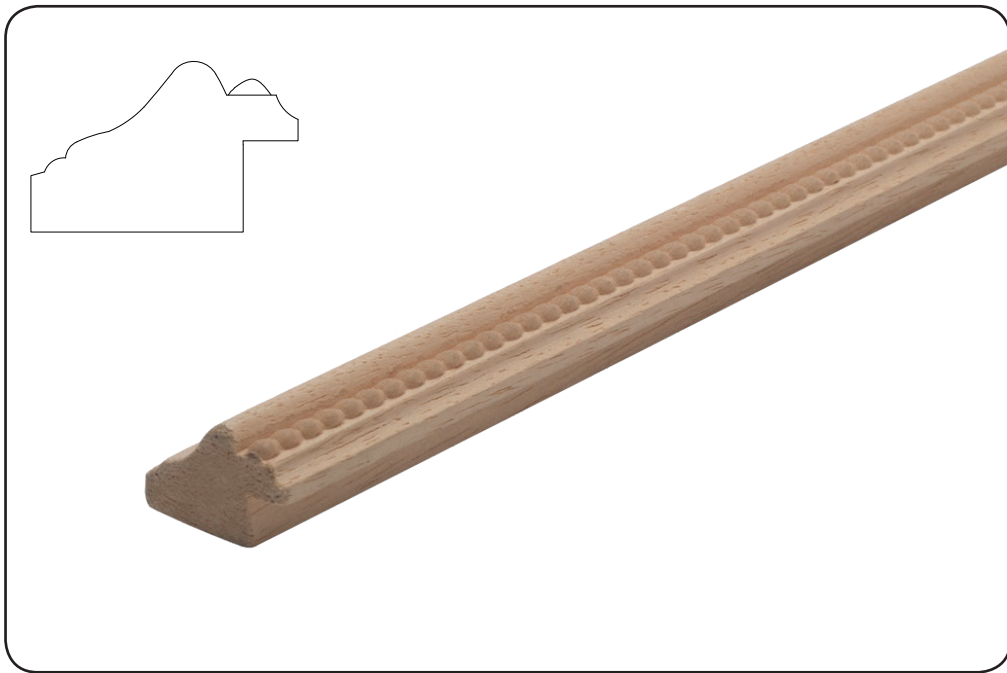

**Baby Duck**

H 22 mm L 34 mm h Battente 11 mm

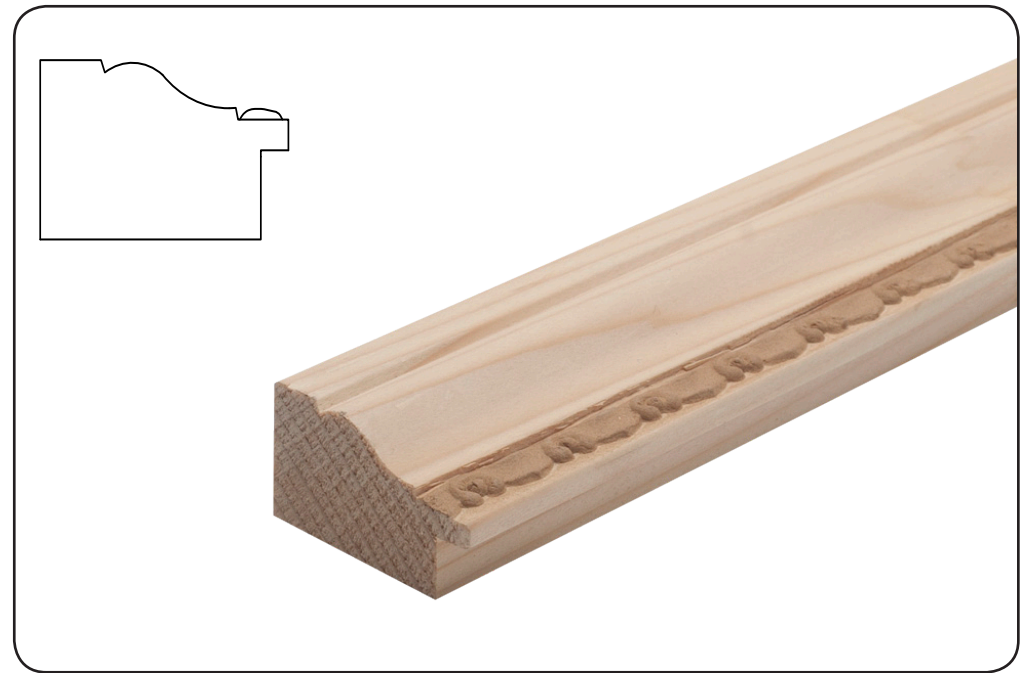

**402p**

H 28 mm L 47 mm h Battente 13 mm

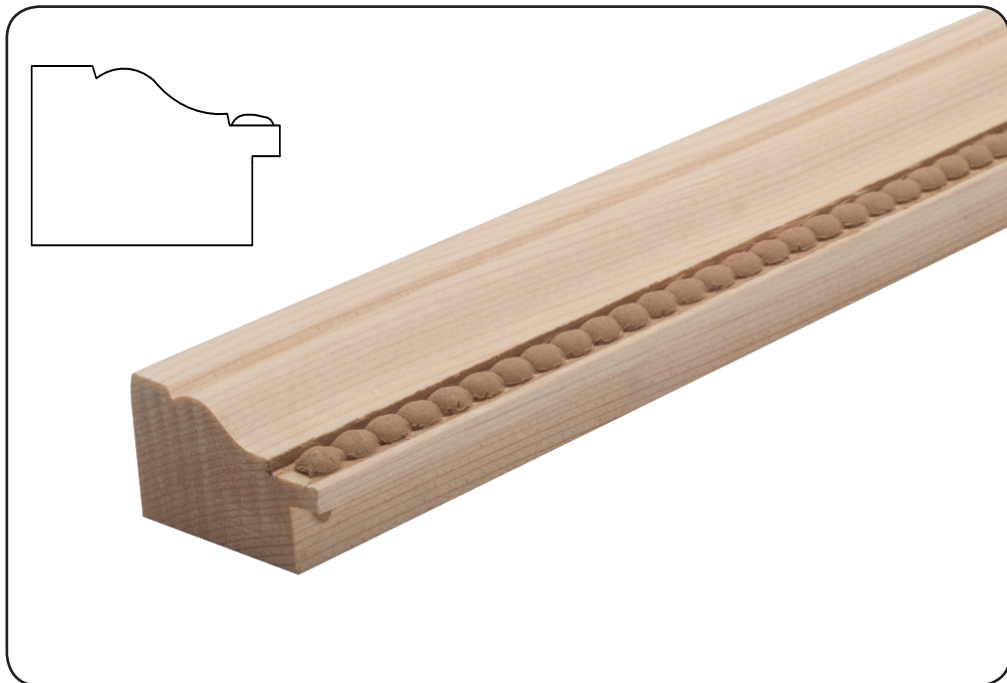

**403p**

H 28 mm L 47 mm h Battente 13 mm

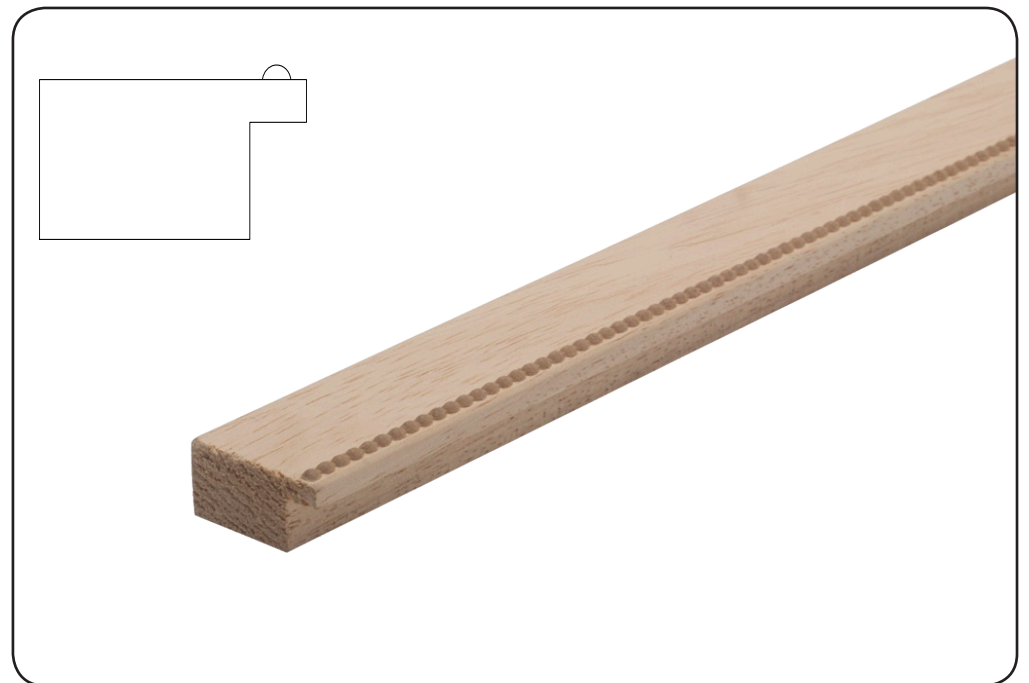

**405p**

H 15 mm L 30 mm h Battente 10 mm



**408p**  
H 22 mm L 80 mm h Battente 15 mm



**409p**  
H 17 mm L 40 mm h Battente 10 mm

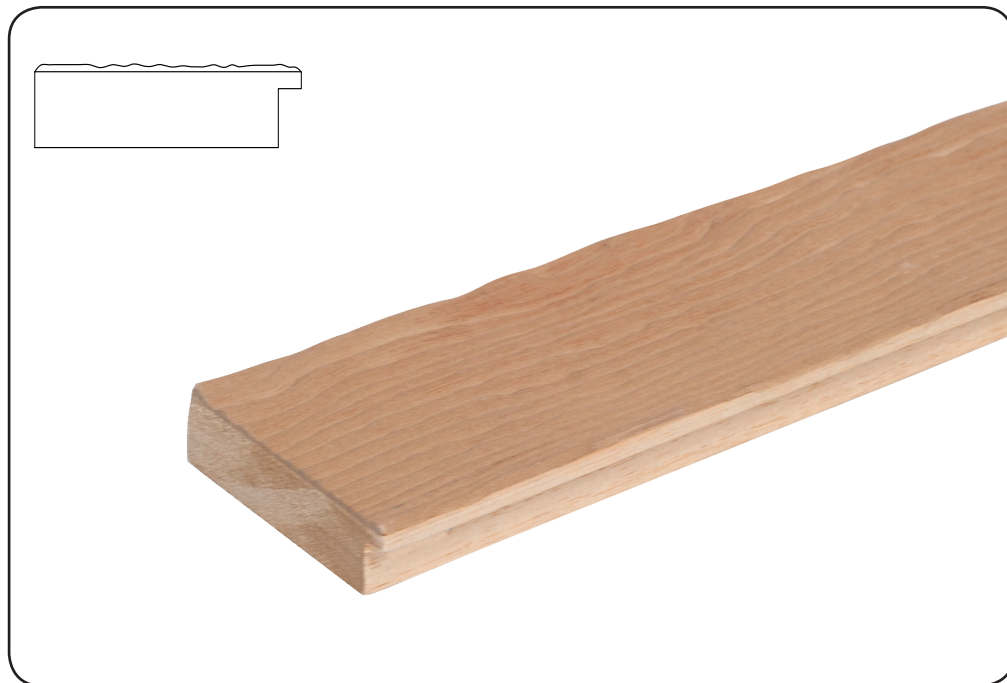

**410p**  
H 22 mm L 80 mm h Battente 15 mm

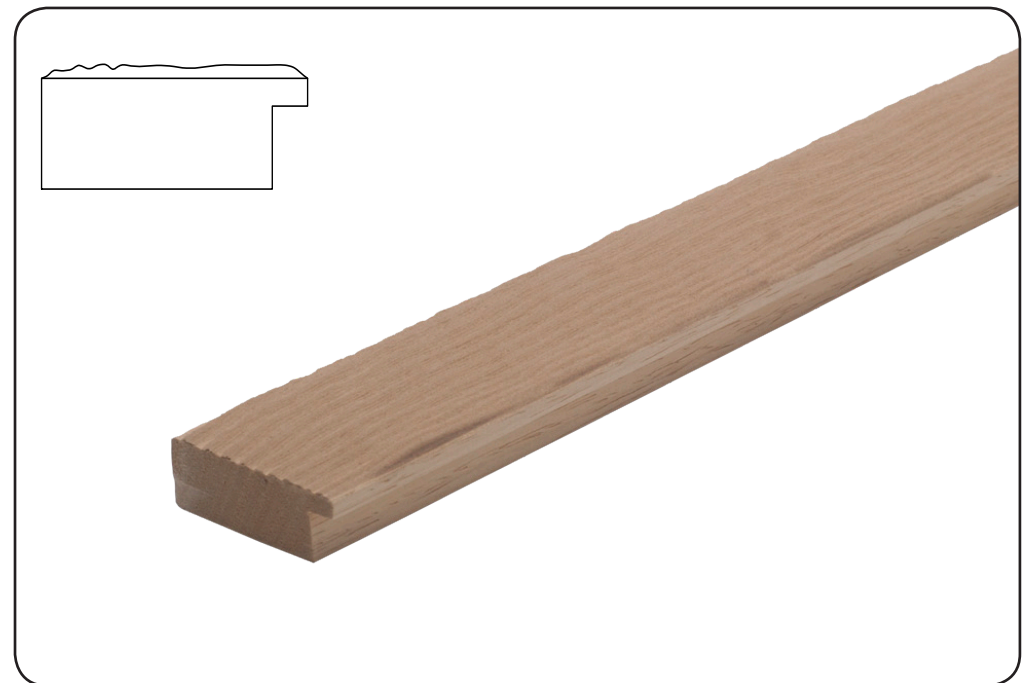

**411p**  
H 17 mm L 45 mm h Battente 10 mm

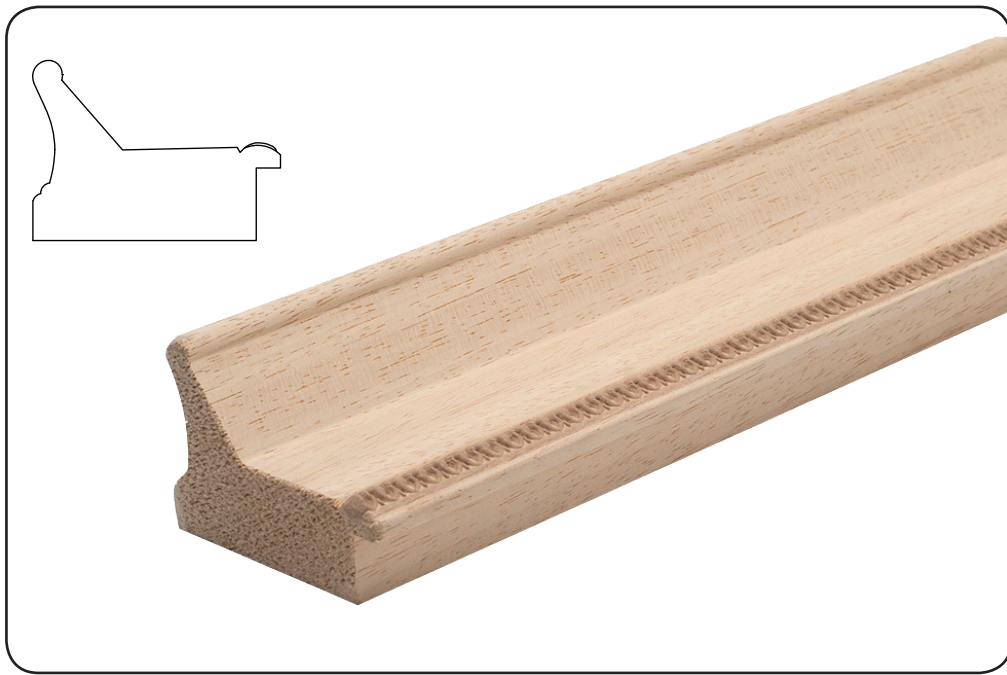

**412p**

H 44 mm L 63 mm h Battente 16 mm





ARTICOLI LISCI  
*Smooth articles*

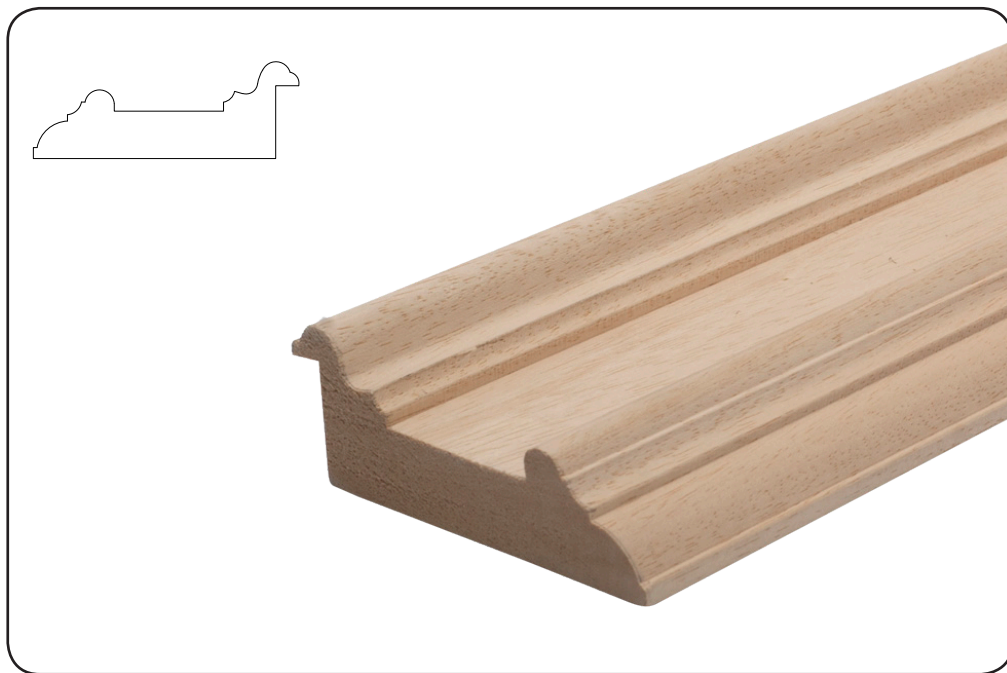

**149**  
H 35 mm L 95 mm h Battente 27 mm

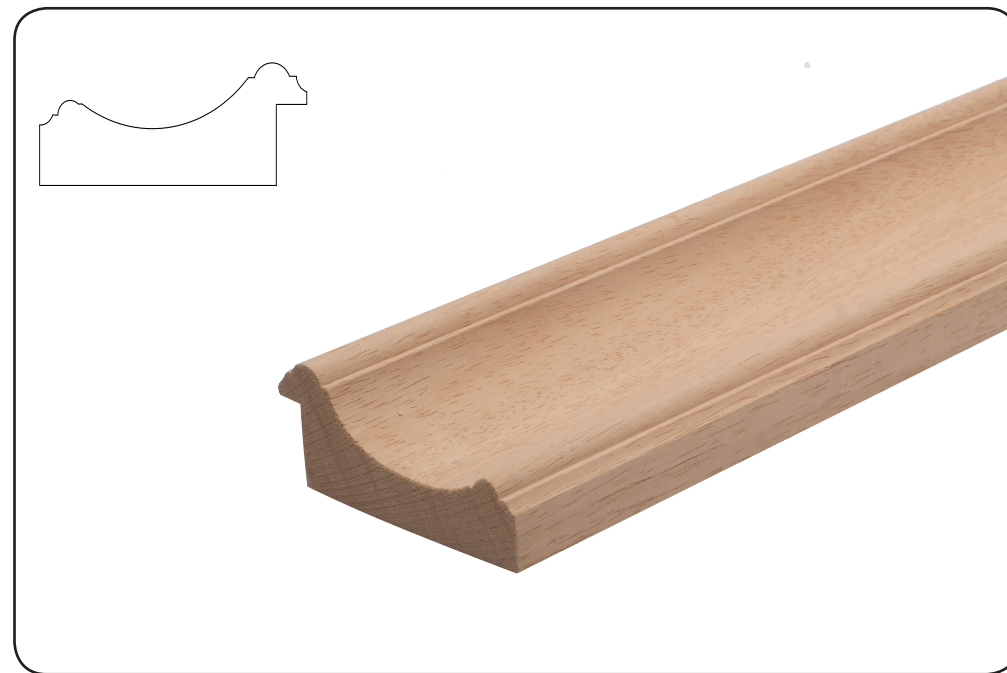

**201**  
H 35 mm L 83 mm h Battente 23 mm



**202**  
H 49 mm L 71 mm h Battente 24 mm

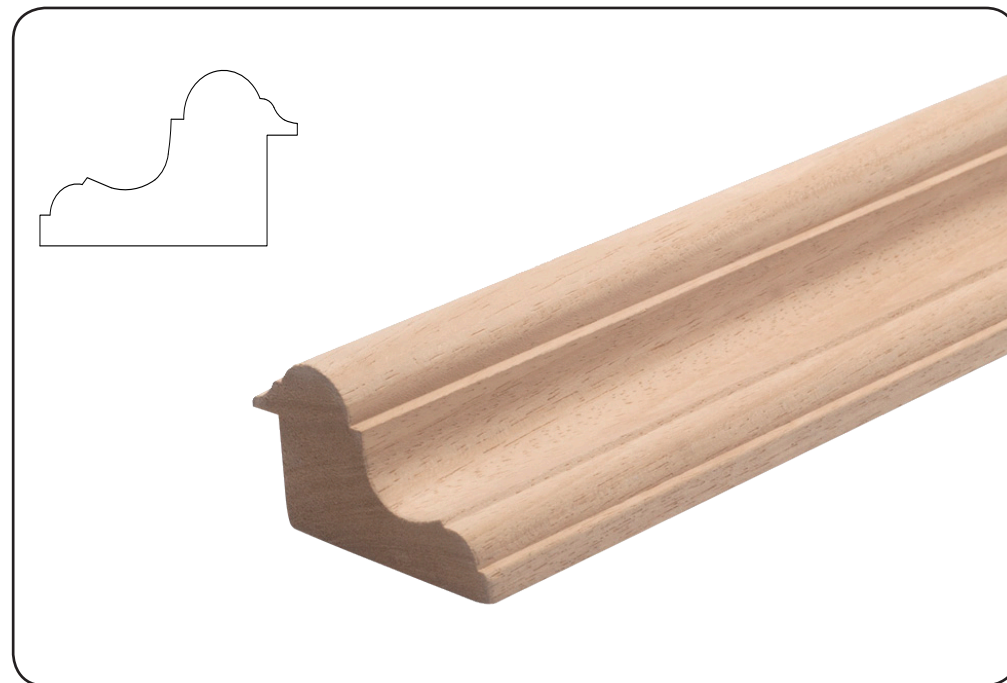

**203**  
H 39 mm L 67 mm h Battente 24 mm

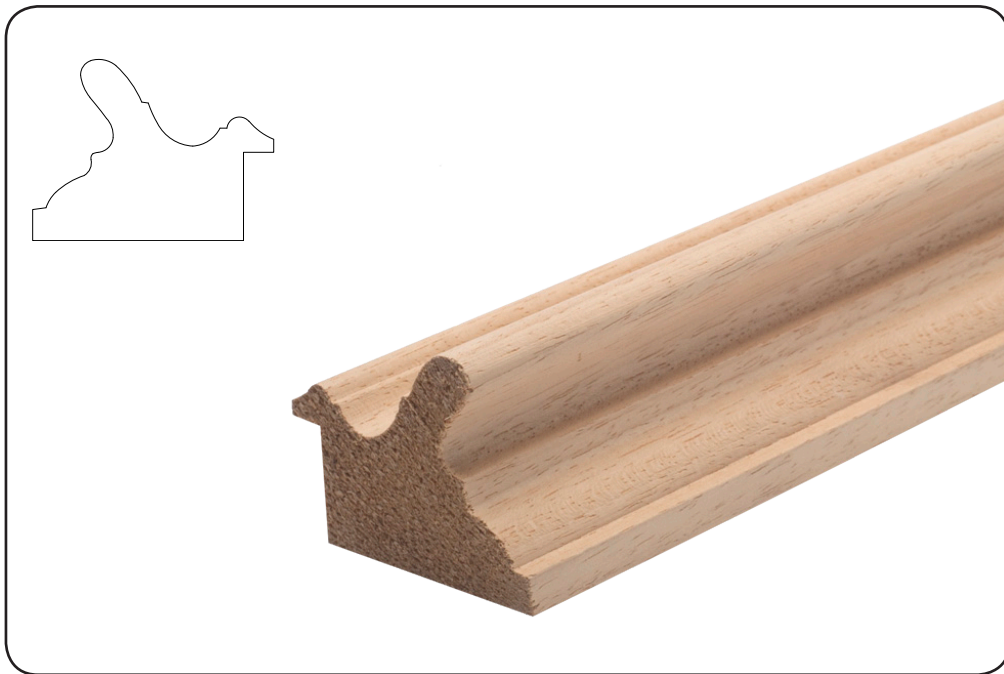

**204**  
H 52 mm L 68 mm h Battente 26 mm

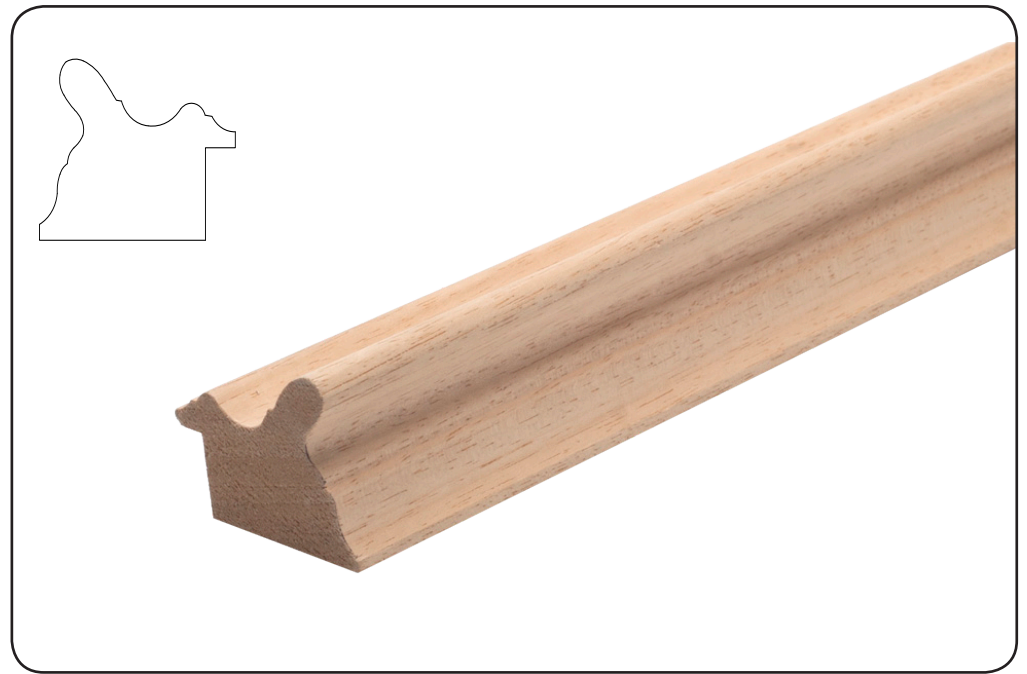

**205**  
H 40 mm L 50 mm h Battente 19 mm

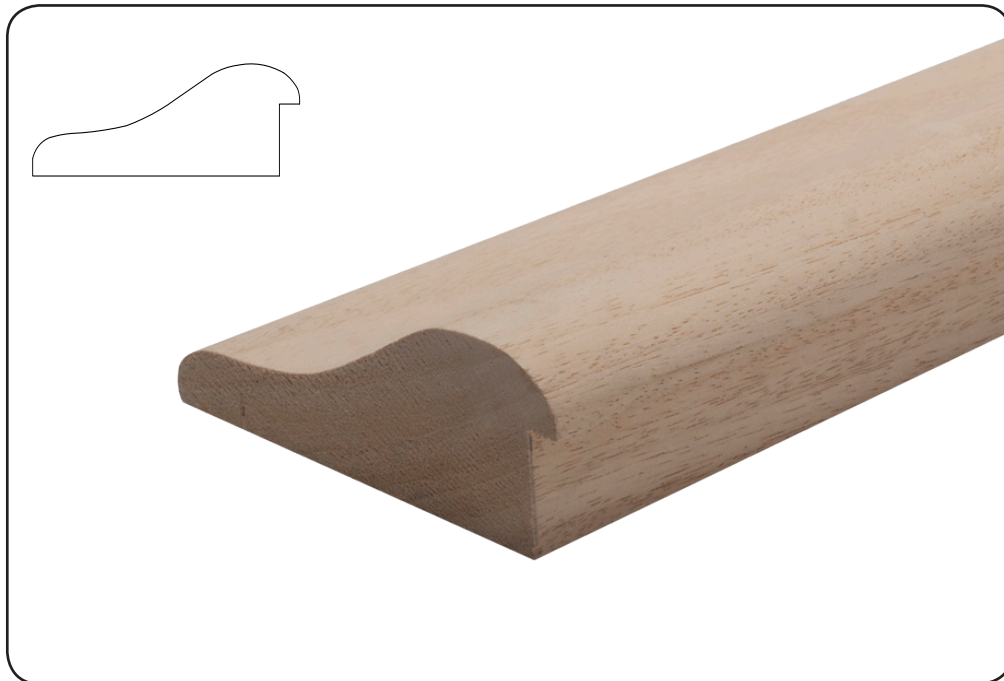

**206**  
H 44 mm L 116 mm h Battente 29 mm

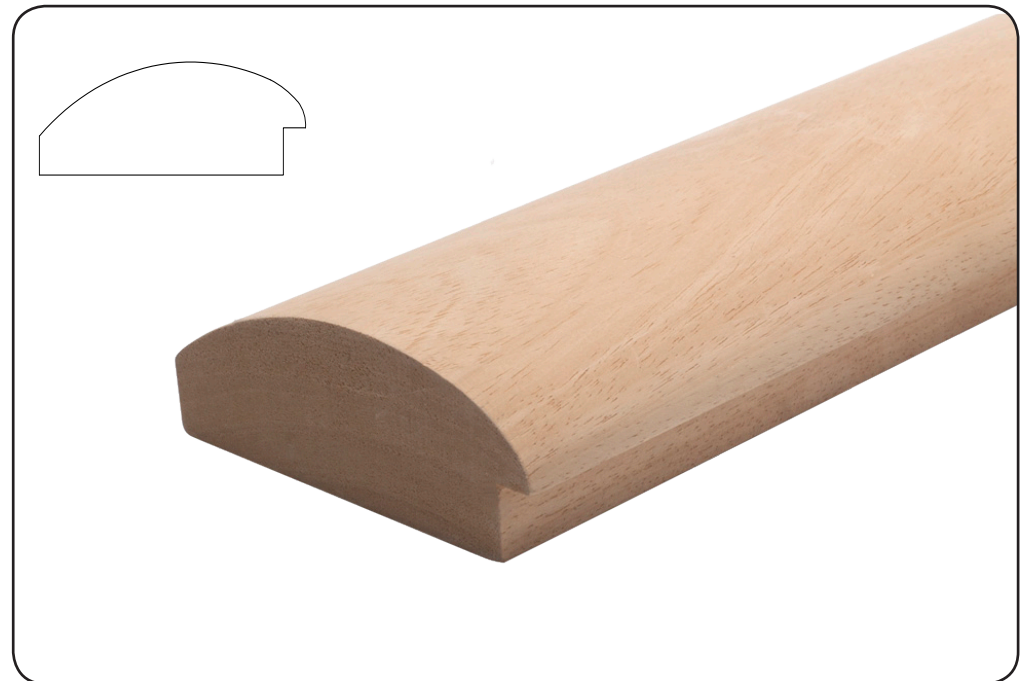

**207**  
H 44 mm L 116 mm h Battente 20 mm



**208**  
H 34 mm L 86 mm h Battente 20 mm



**209**  
H 30 mm L 112 mm h Battente 24 mm

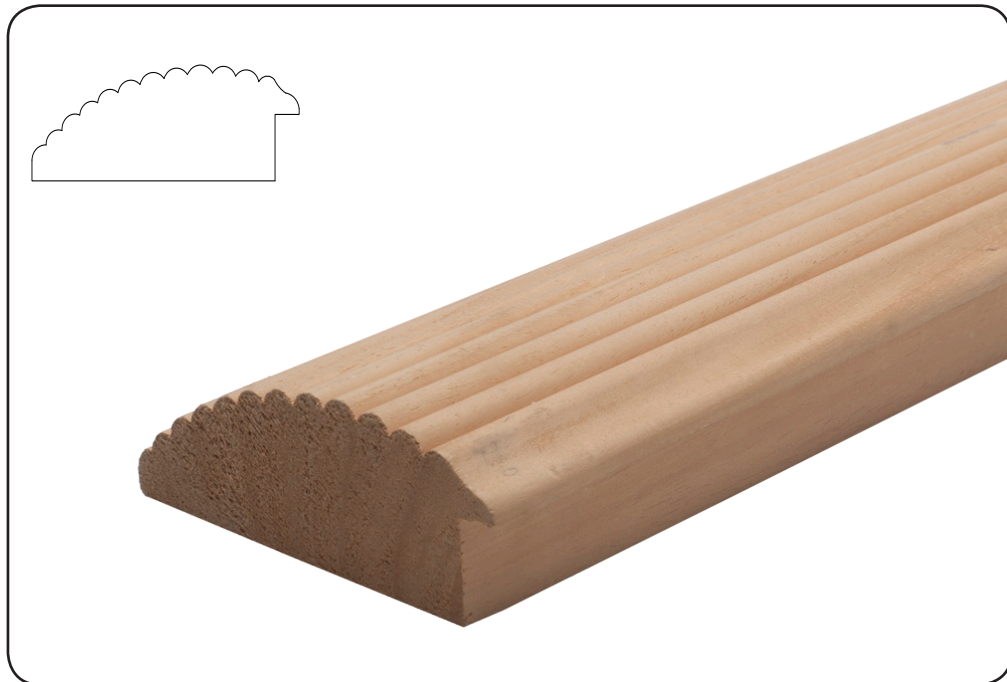

**210**  
H 44 mm L 115 mm h Battente 27 mm

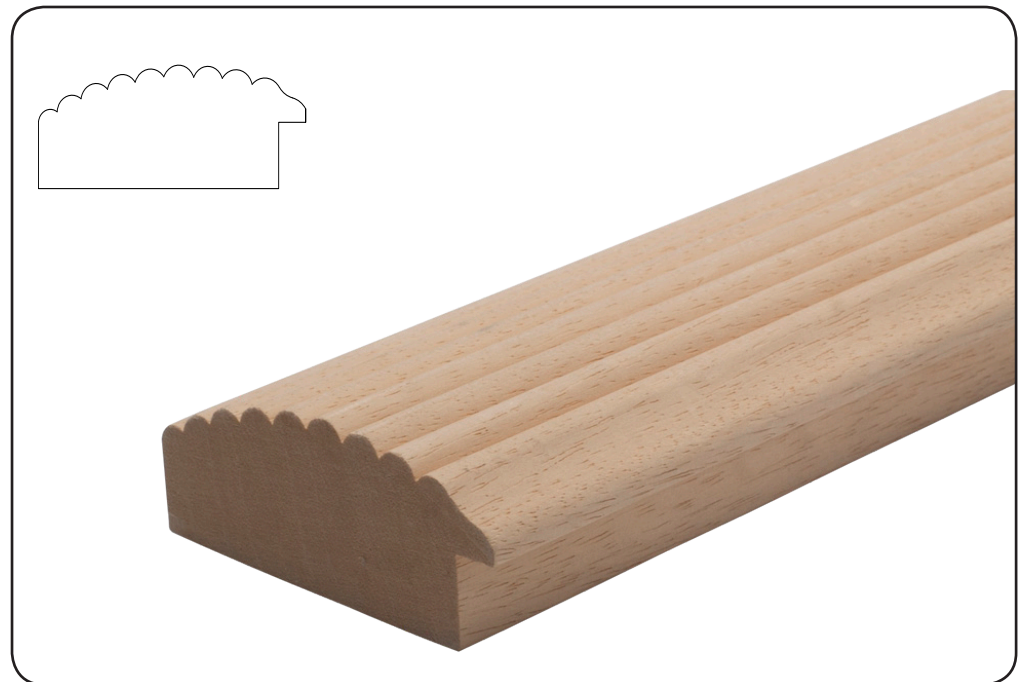

**211**  
H 38 mm L 94 mm h Battente 20 mm

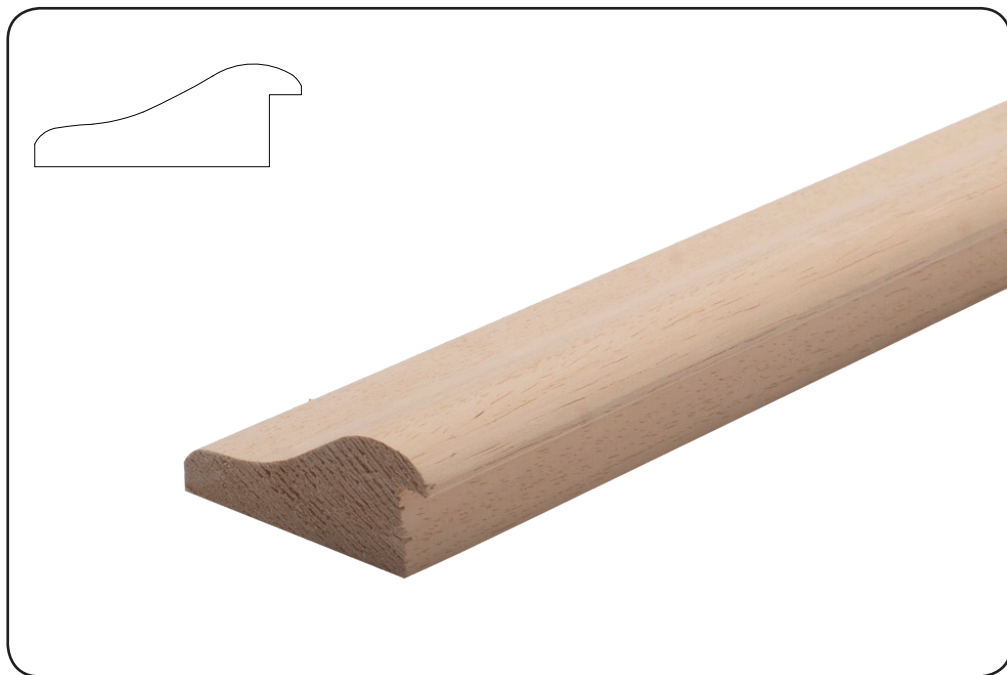

**221**  
H 30 mm L 72 mm h Battente 20 mm

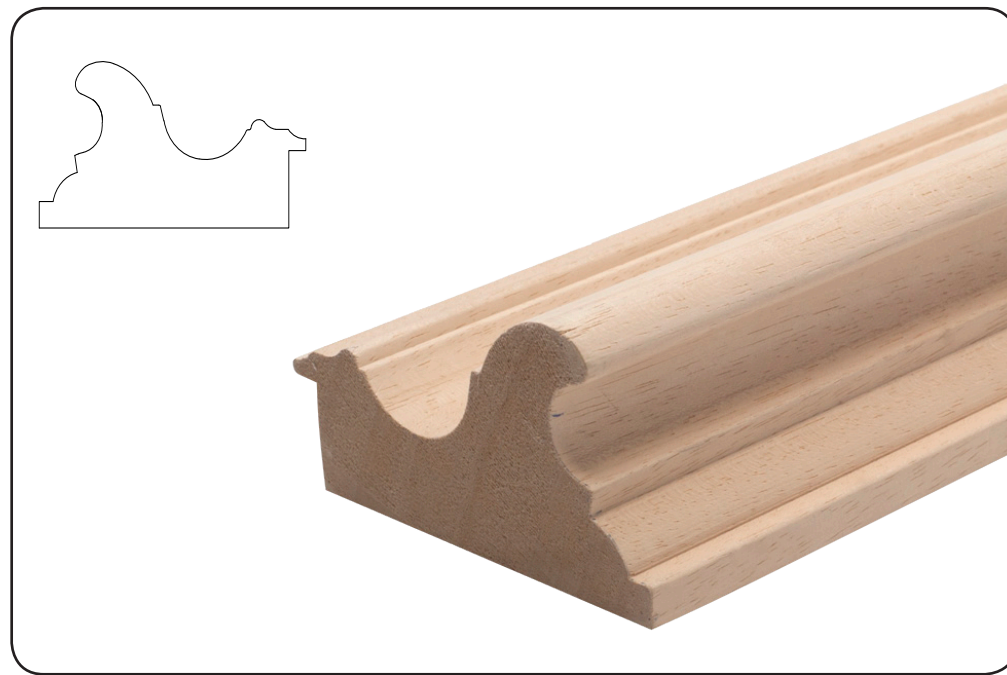

**222**  
H 62 mm L 118 mm h Battente 27 mm

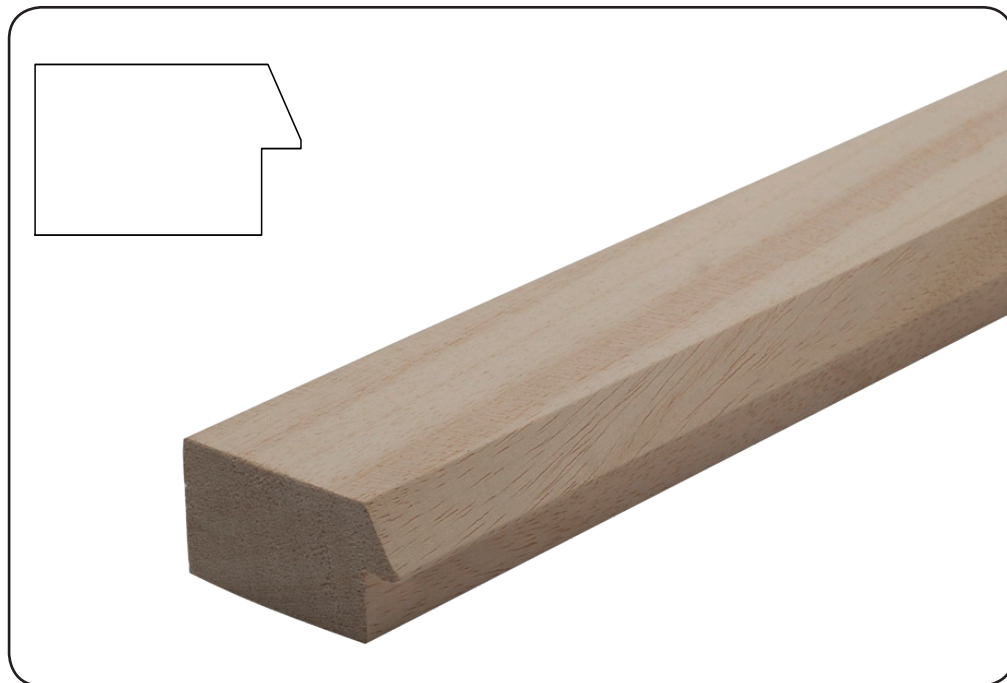

**237**  
H 25 mm L 47 mm h Battente 13 mm



**241**  
H 30 mm L 67 mm h Battente 15 mm



**LISTELLI**  
*Mouldings*

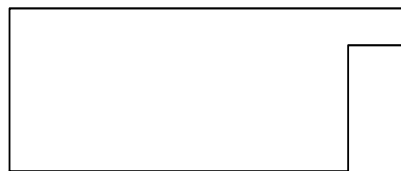
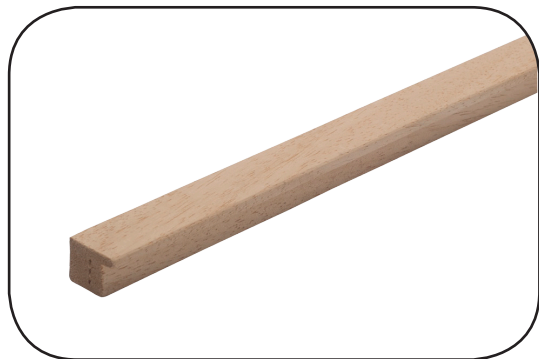
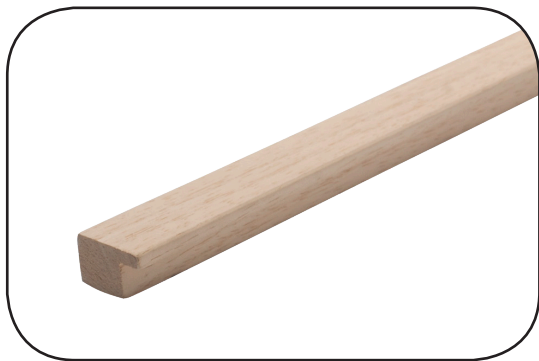

I listelli sono disponibili nelle seguenti misure:  
*The mouldings are available with the following measurements:*

BATTENTE 10 mm

- 20x15
- 25x17
- 30x15
- 40x15
- 45x15
- 50x15
- 55x15
- 70x15

BATTENTE 15 mm

- 40x20
- 50x20
- 80x20

BATTENTE 20 mm

- 100x25

BATTENTE 25 mm

- 80x30

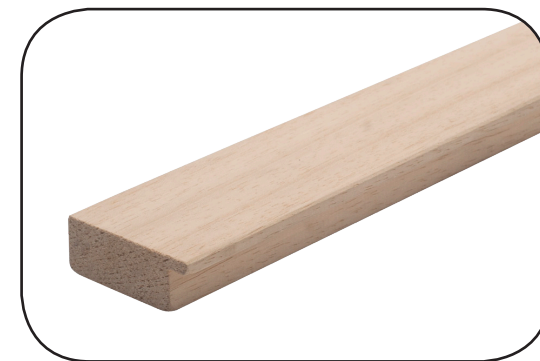
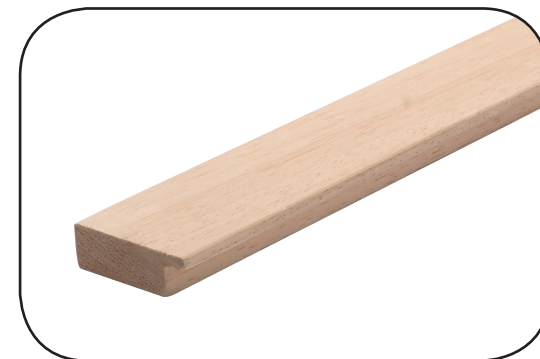

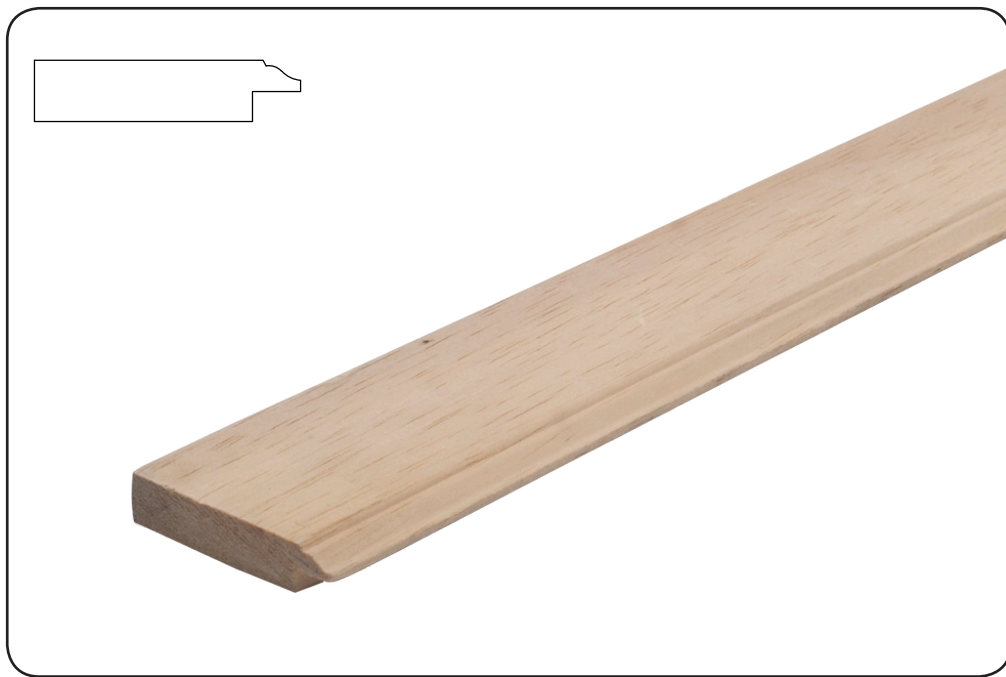

**Passepartout con guscio in varie misure:**

- 35x10
- 45x10
- 55x10

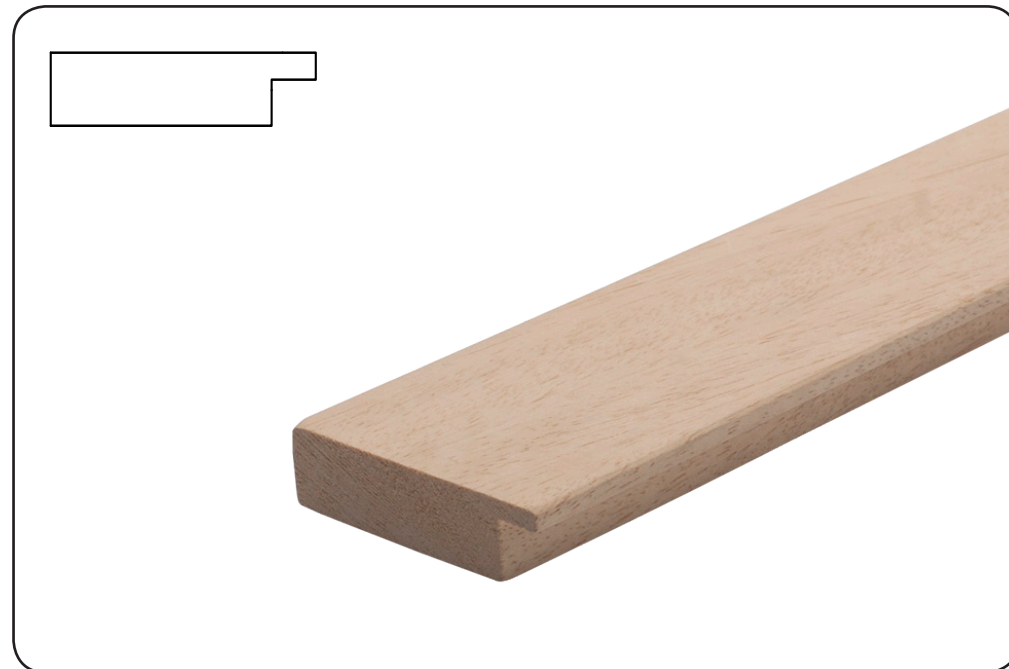

**Passepartout senza guscio in varie misure:**

- 45x10
- 55x10





**LV45**  
H 15 mm L 45 mm h Battente 10 mm



**LV70**  
H 15 mm L 70 mm h Battente 10 mm



**Telaio**  
H 20 mm L 44 mm



# ASTE A CASSETTA

*Grey-state profiles*

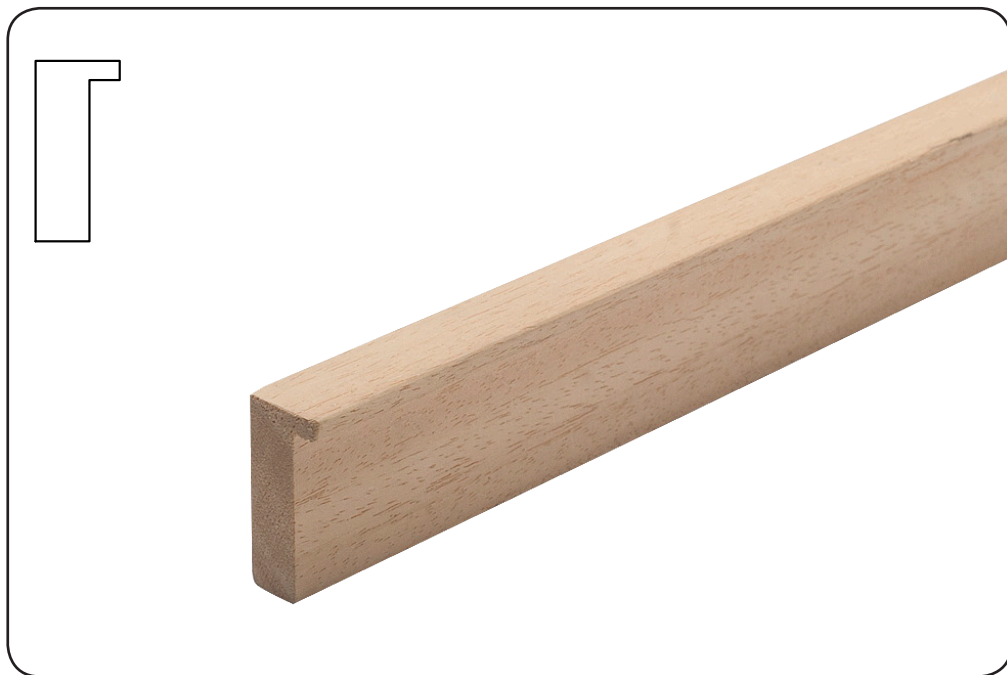

Cassetta 33 -34 - 35

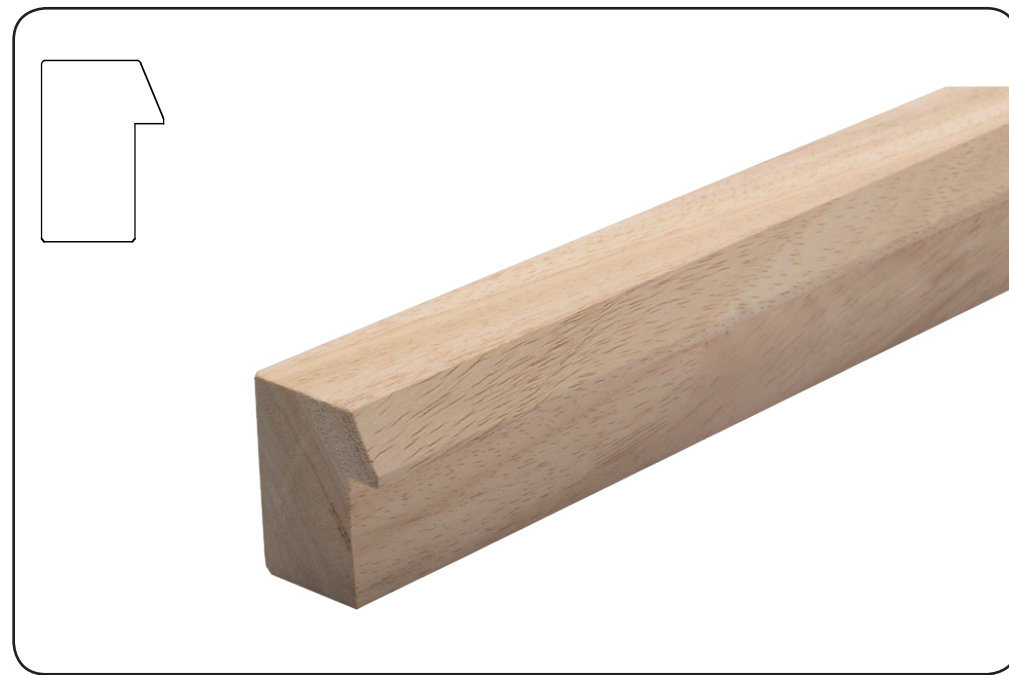

Cassetta 40



Cassetta 50

Le aste a cassetta sono disponibili nelle seguenti misure  
*Grey-state profiles are available with the following measurements*

**Cassetta 33** - H 45 mm L 20 mm h Battente 39 mm

**Cassetta 34** - H 30 mm L 15 mm h Battente 26 mm

**Cassetta 35** - H 53 mm L 22 mm h Battente 48 mm

**Cassetta 40** - H 43 mm L 34 mm h Battente 28 mm

**Cassetta 50** - H 40 mm L 47,5 mm h Battente 41 mm



# ARTICOLI BALZELLATI

*Scallop-edged articles*

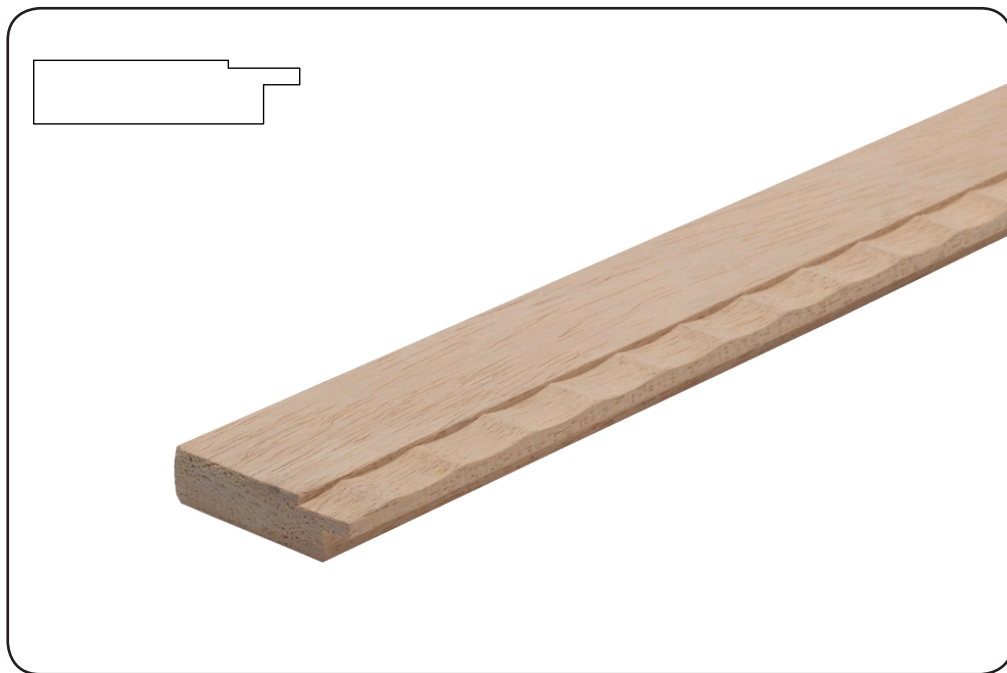

**Pass. B**  
H 10 mm L 44 mm h Battente 8 mm



**301**  
H 21 mm L 16 mm h Battente 12 mm

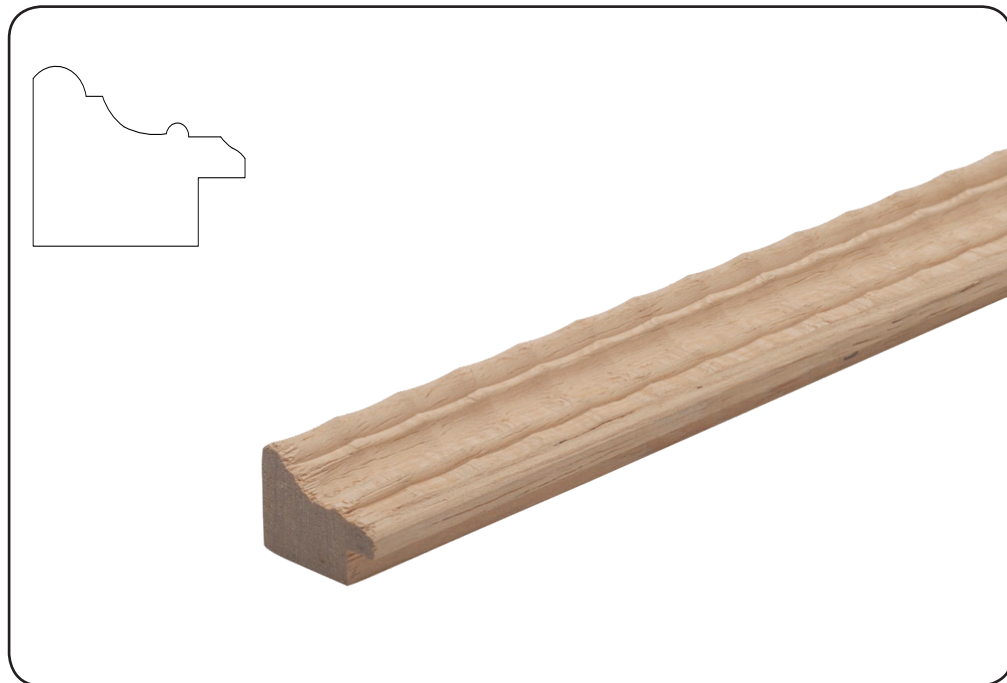

**302**  
H 21 mm L 28 mm h Battente 9 mm



**303**  
H 41 mm L 43 mm h Battente 16 mm

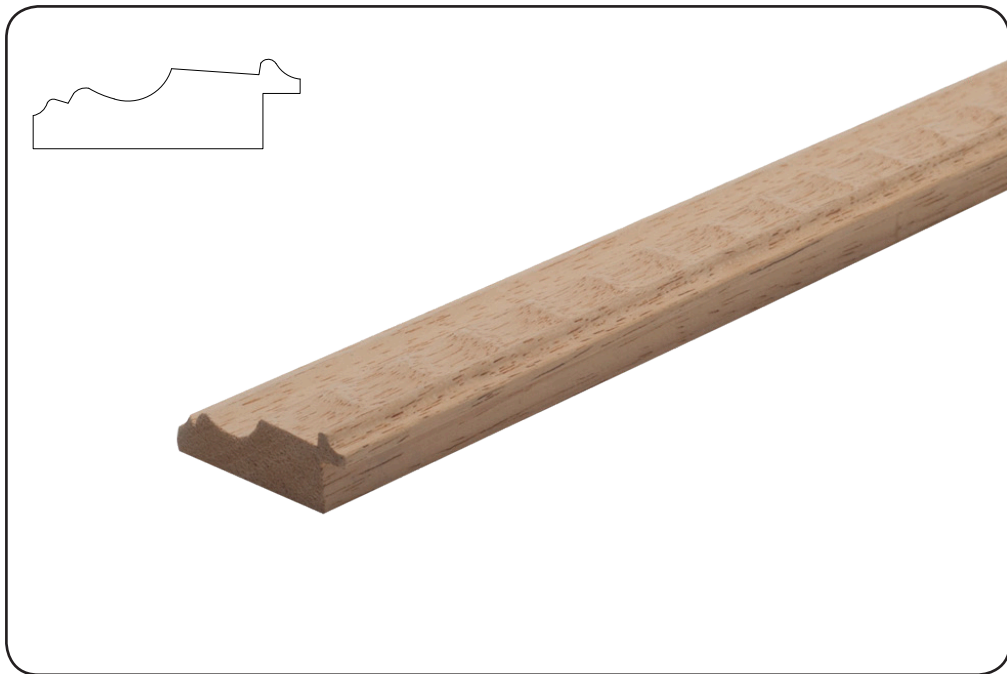

**304**  
H 18 mm L 48 mm h Battente 11 mm



**305**  
H 32 mm L 32 mm h Battente 12 mm



**306**  
H 18 mm L 17 mm h Battente 9 mm

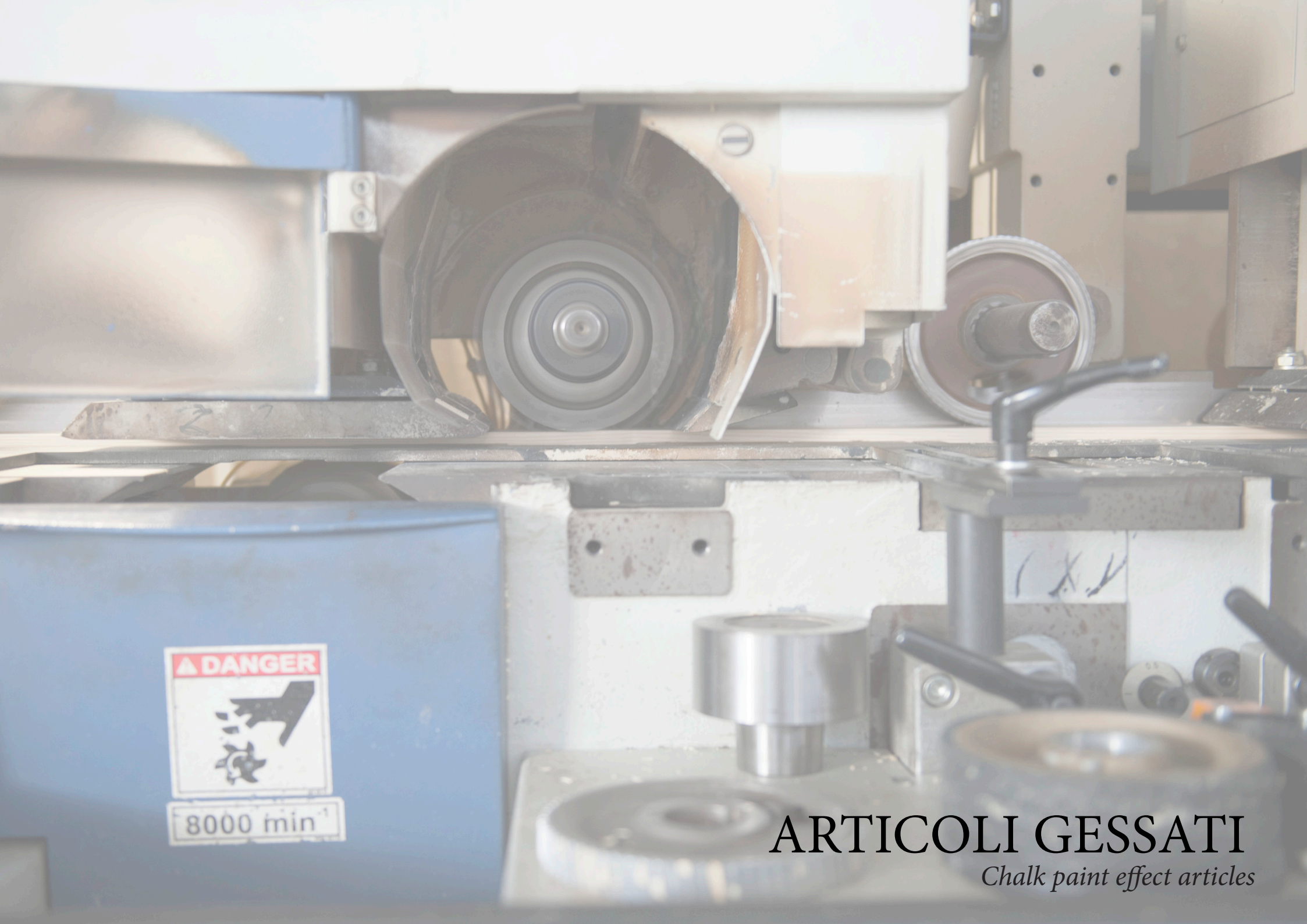

**▲ DANGER**  
  
8000 min<sup>-1</sup>

**ARTICOLI GESSATI**  
*Chalk paint effect articles*



**206 gessato**  
H 44 mm L 116 mm Battente 29 mm



**207 gessato**  
H 44 mm L 116 mm Battente 20 mm



**208 gessato**  
H 34 mm L 86 mm Battente 20 mm



**209 gessato**  
H 30 mm L 112 mm Battente 24 mm





**221 gessato**

H 30 mm L 72 mm Battente 20 mm



# I NOSTRI IMBALLI

*Our packaging*



